



Teka



User's guide

Models

HLB

HLB P

ES Guía de Uso
PT Guia de Utilização
EN User's guide
FR Guide d'Utilisation
DE Bedienungsanleitung

NE Gebruikershandleiding
EL Οδηγός χρήσης



ESPAÑOL



Por favor, antes de utilizar su horno por primera vez, lea atentamente las instrucciones de instalación y mantenimiento incluidas en su horno.

Dependiendo del modelo, los accesorios incluidos en su horno pueden variar respecto a los mostrados en las imágenes.

PORTUGUÊS



Antes de utilizar o forno pela primeira vez, leia atentamente as instruções de instalação e manutenção fornecidas juntamente com o forno.

Dependendo do modelo, os acessórios incluídos no forno podem variar em relação às imagens apresentadas.

ENGLISH



Before using your oven for the first time, please read the installation and maintenance instructions for your oven carefully.

Depending on the model, the accessories included with your oven may vary from those shown in the images.

FRANÇAIS



Avant la première utilisation de votre four, veuillez lire attentivement les instructions d'installation et d'entretien fournies avec votre four.

Selon les modèles, il est possible que les accessoires fournis avec votre four soient différents de ceux indiqués sur les images.

DEUTSCH



Bevor Sie den Backofen zum ersten Mal verwenden, lesen Sie bitte die zu Ihrem Backofen gehörenden Einbau- und Wartungsanweisungen aufmerksam durch.

Je nach Modell können die Zubehörteile Ihres Backofens von den in den Abbildungen dargestellten abweichen.

NEDERLANDS



Lees voordat u uw oven voor het eerst gaat gebruiken aandachtig de bij uw oven meegeleverde installatie- en onderhoudsinstructies.

Afhankelijk van het model kunnen de bij uw oven gevoegde accessoires afwijken van de accessoires die in de afbeeldingen worden getoond.

ΕΛΛΗΝΙΚΑ



Προτού χρησιμοποιήσετε τον φούρνο σας για πρώτη φορά, διαβάστε προσεκτικά τις οδηγίες εγκατάστασης και συντήρησης που τον συνοδεύουν.

Ανάλογα με το μοντέλο, τα εξαρτήματα που περιέχει ο φούρνος σας ενδέχεται να διαφέρουν σε σχέση με αυτά που απεικονίζονται.

Descripción del horno

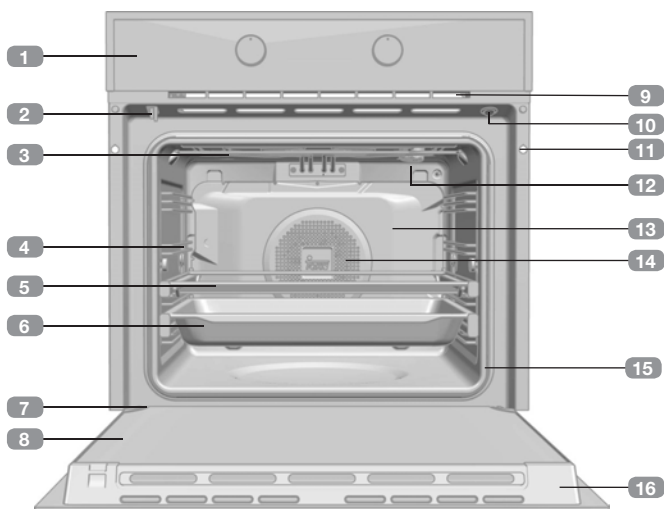





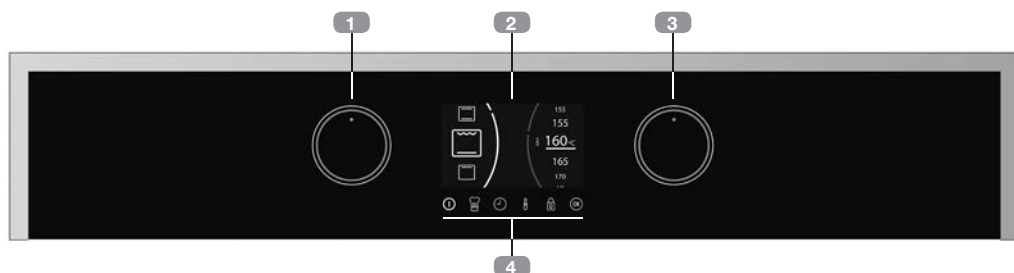

- 1 Frente de mandos
- 2 Bloqueo / Interruptor de puerta (solo para modelos pirolíticos)
- 3 Resistencia de grill
- 4 Soporte bandejas
- 5 Parrilla
- 6 Bandeja
- 7 Bisagra
- 8 Cristal interior
- 9 Salida de aire de refrigeración
- 10 Interruptor de puerta (solo para modelos NO pirolíticos)
- 11 Fijación al mueble
- 12 Lámpara
- 13 Panel trasero
- 14 Turbina
- 15 Junta de horno
- 16 Puerta

Frontal de mandos



- 1 Mando para desplazarse por los menús de la parte izquierda de la pantalla. Selector de modos de cocinado.
- 2 Pantalla de visualización.
- 3 Mando para desplazarse por los menús de la parte derecha de la pantalla. Selector de ajustes de cocinado.
- 4 Teclas.

-  **Encendido / Apagado del horno.**
-  **Modificación de temperatura del horno.**
-  **Acceso al asistente personal de cocinado (PCA)**
-  **Activación / Desactivación del bloqueo del teclado / puerta según modelos.**
-  **Acceso a las funciones de temporización y programación del horno.**
-  **Tecla de validación. Apagado / Encendido de la luz interior.**

Encendido y puesta en hora

Al conectar el horno por primera vez a la red, aparecerá el logotipo seguido de la indicación 12:00 parpadeando.

Para poder trabajar con el horno, es necesario poner en hora el reloj.

Para ello seleccione las horas con el mando izquierdo y los minutos con el mando derecho.

Valide la selección con la tecla  o espere unos segundos.

Escuchara una señal acústica como confirmación, y la hora quedará fijada en la pantalla.

Para modificar la hora:

Con el horno en reposo (pantalla de inicio), mantenga presionada la tecla  hasta que la hora aparezca parpadeando. Siga los pasos descritos para modificar la hora.



ATENCIÓN

La sensibilidad de las teclas touch se adapta continuamente a las condiciones ambientales. Al conectar el horno a la red tenga la precaución de que la superficie de cristal del frontal de mandos esté limpia y libre de cualquier obstáculo.



Si al tocar el cristal, la pantalla no responde correctamente, entonces es necesario que desconecte el horno de la red eléctrica y tras un instante vuelva a conectarlo. De esta forma los sensores se habrán ajustado automáticamente y reaccionarán de nuevo al tocar con el dedo.

MODO DEMO (Función especial para exposiciones)

Con el modo DEMO activado, puede manejarse el horno sin calentar.

Se recomienda activar este modo si el horno va a instalarse en una exposición con conexión a red.

Activación del modo DEMO

Antes de poner el reloj en hora, pulsar simultáneamente las teclas  y  , hasta que en la pantalla aparezca la indicación «DEMO Mode ON».

A continuación ponga el horno en hora.

La palabra «DEMO» aparecerá permanentemente en la pantalla y el horno puede operarse normalmente, pero no calentará.

Para desactivar el modo DEMO, debe desconectar el horno de red.



ATENCIÓN

En caso de un corte de suministro eléctrico, se borrará toda la programación de su reloj electrónico.

Aparecerá la indicación 12:00.

Puede poner el reloj en hora siguiendo las instrucciones anteriores.

Si el horno tenía la puerta bloqueada antes del corte de suministro, el símbolo de bloqueo se iluminará hasta que la puerta se desbloquee.

Esto puede llevar varios minutos, dependiendo de la temperatura a la que se encuentra el horno, y durante este tiempo no podrá poner el reloj en hora.

Una vez desbloqueada la puerta, puede poner el reloj en hora siguiendo las instrucciones anteriores.



Descripción de la pantalla de control

A continuación se describe la información que encontrará en la pantalla de visualización de su horno y cómo esta se mostrará.

PANTALLA DE INICIO / REPOSO

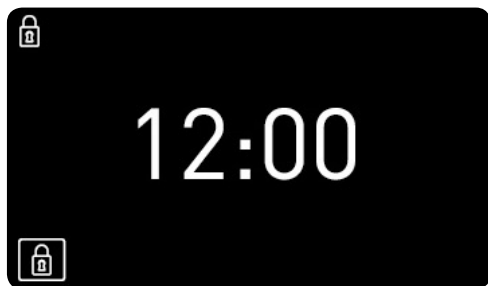
Esta pantalla aparecerá cuando el horno no esté funcionando, pero esté conectado a la red.



Si el bloqueo de teclado o el de puerta están activados, los símbolos  y  aparecerán en la zona izquierda de la pantalla.

Si ha programado un aviso, la pantalla dejará de mostrar la hora, y mostrará la cuenta atrás, como se indica en la imagen siguiente.

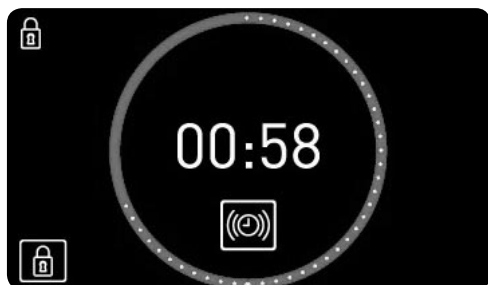

PANTALLA DE SELECCIÓN



Selección de función.

Durante la selección de una función de cocción, receta automática o función de reloj, la pantalla aparecerá dividida en dos sectores:

SECTOR IZQUIERDO. En esta zona de la pantalla se muestran las funciones de cocción, recetas automáticas o funciones de programación del reloj disponibles para su selección.

Para seleccionar cualquiera de ellas, gire el mando izquierdo hasta que la función deseada aparezca aumentada y valide la selección con la tecla  (si usted no toca ninguna tecla, pasados unos segundos el horno validará la selección automáticamente).

SECTOR DERECHO. En esta zona de la pantalla, se muestran los valores a ajustar en función del modo seleccionado: temperatura, peso, duración, hora de finalización,...

Para seleccionar un valor, gire el mando derecho hasta que el valor deseado aparezca aumentado y valide la selección con la tecla  (si usted no toca ninguna tecla, pasados unos segundos el horno validará la selección automáticamente).

PANTALLA DE COCINADO

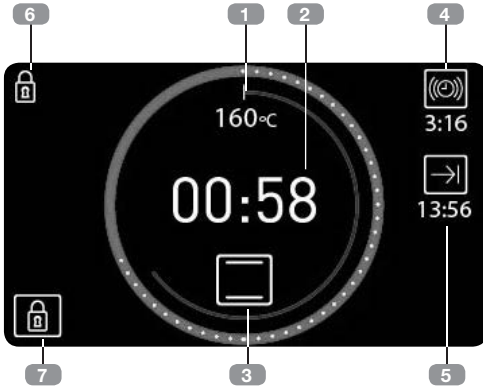

Durante el cocinado, la información sobre la situación del horno aparecerá en la pantalla organizada alrededor de dos círculos centrales:

Círculo interior de temperatura. En color rojo. Representa, a escala, la temperatura seleccionada.

Círculo exterior de tiempo.

- En color rojo cuando muestra el tiempo que el horno lleva cocinando. Aparecerá un punto blanco cada 2 minutos.
- En color azul cuando muestra el tiempo que falta para que el cocinado termine (cuenta atrás). Desaparecerá un punto blanco cada 2 minutos.

Dentro de estos círculos, encontrará la siguiente información sobre el cocinado:

1. Temperatura seleccionada. El símbolo °C, parpadeará hasta que se alcance la temperatura seleccionada y siempre que el horno esté transmitiendo calor al alimento.

2. Duración del cocinado.

- Si no ha programado el reloj, mostrará el tiempo que el horno lleva cocinando y la circunferencia de tiempo aparecerá en color rojo.
- Si ha realizado alguna programación, mostrará el tiempo que falta para que el cocinado termine (cuenta atrás) y la circunferencia de tiempo aparecerá en color azul.
- Si el horno está programado, pero en situación de espera (no ha empezado a cocinar), se mostrará la duración total de cocinado programada.

3. Función de cocinado o receta automática seleccionada.

Fuera de los círculos, encontrará la siguiente información sobre funciones adicionales:

ZONA DERECHA DE LA PANTALLA. Si ha programado funciones de tiempo, la información relativa a estas funciones se muestra en la zona derecha de la pantalla.

4.  Avisador. Cuenta atrás para la finalización del aviso programado.

5.  Hora de Finalización.

ZONA IZQUIERDA DE LA PANTALLA. Información sobre Funciones de seguridad activadas.

6.  Bloqueo de teclado. Se iluminará cuando esté activado el bloqueo de seguridad de niños.

7.  Bloqueo de puerta. SÓLO PARA MODELOS PIROLÍTICOS. Se iluminará cuando el bloqueo manual de puerta esté activado.

Cocinado con funciones tradicionales

FUNCIONES DEL HORNO



INFORMACIÓN

Para una descripción de uso de cada una de las funciones, consulte la guía de cocinados incluida en su horno.



DESCONEXIÓN



CONVENCIONAL



CONVENCIONAL CON TURBINA



GRILL Y SOLERA



MAXIGRILL



GRILL



SOLERA



PIZZA



TURBO



ECO



A FUEGO LENTO



FERMENTAR MASAS



DESCONGELACIÓN



HYDROCLEAN



PIROLISIS (según el modelo)



Funciones que incorporan precalentamiento rápido automático

PARA COCINAR CON LAS FUNCIONES TRADICIONALES



Selección de función.

Encienda el horno tocando la tecla .

Gire el mando izquierdo hasta que la función deseada aparezca aumentada.

A continuación, aparecerá a la derecha la temperatura recomendada para la función elegida.



Si lo desea, puede modificar la temperatura girando el mando derecho.

Valide la selección con la tecla .

El horno empezará a cocinar.

En cualquier momento del cocinado usted puede:

- **Cambiar la función de cocinado**, girando el mando izquierdo.

- **Modificar la temperatura de cocinado** girando el mando derecho.
- **Programar un aviso o una duración / hora fin de cocinado**. Tocando la tecla .
- **Modificar la programación de avisos o duración/hora fin programados**. Tocando la tecla .



INFORMACIÓN

Para programar o modificar una programación, consulte el apartado «Programación temporizada del cocinado» que encontrará más adelante en esta guía de uso.

PRECALENTAMIENTO RÁPIDO AUTOMÁTICO

































Las funciones señaladas, incorporan precalentamiento rápido automático.

Durante el precalentamiento rápido, se ilumina el símbolo .

Se recomienda no introducir el alimento hasta que este símbolo se apague.

Cocinado con el Asistente Personal de Cocinado (PCA)

RECETAS AUTOMÁTICAS DEL HORNO

AVES		 POLLO	
		 PATO	
		 GANSO	
		 PAVO	
		 MUSLOS	
CARNES		 COCHINILLO	
		 BUEY	
		 CORDERO	
		 CHULETAS	
PESCADOS		 MERLUZA	
		 SALMÓN	
PANES		 PAN BLANCO	
		 PAN MORENO	
		 PAN INTEGRAL	
PIZZAS		 PIZZA GRUESA	
		 PIZZA FINA	
POSTRES		 PASTEL DE MOLDE	
		 PASTEL DE FRUTAS GRANDE	
		 PASTEL DE FRUTAS PEQUEÑO	
		 PASTEL EN BANDEJA	

 Recetas que requieren precalentar el horno en vacío.

 Recetas que requieren dar la vuelta al alimento.

PARA COCINAR CON EL ASISTENTE PERSONAL DE COCINADO

Encienda el horno tocando la tecla .

Toque la tecla .



Selección de receta.

Gire el mando izquierdo hasta que el tipo de alimento que desea cocinar aparezca aumentado.

En el sector derecho de la pantalla, se mostrarán a continuación las recetas disponibles para el tipo de alimento seleccionado. Seleccione con el mando derecho la receta deseada y valide la selección con la tecla .

En el sector derecho de la pantalla, aparecerá a continuación la información que el horno necesita para programar el cocinado.

Según la receta seleccionada, el horno le pedirá que introduzca:

PESO DEL ALIMENTO: Seleccione con el mando derecho y valide con la tecla .

TEMPERATURA: Valide la temperatura propuesta por la receta o seleccione otra con el mando derecho y valide con la tecla .

GRADO DE ACABADO: En algunos cocinados, usted puede seleccionar el grado de acabado:

- **HIGH:** Acabado muy hecho
- **MEDIUM:** Acabado al punto
- **LOW:** Acabado poco hecho

Una vez seleccionados todos los parámetros, valide con la tecla .

El horno empezará a cocinar, y la pantalla de selección dará paso a la pantalla de cocinado, en la que se mostrará la siguiente información:

- Temperatura de cocinado seleccionada
- Tiempo restante de cocinado
- Receta seleccionada

Una vez finalizado el cocinado, sonará una alarma acústica durante 90 segundos aproximadamente y en la pantalla parpadeará el símbolo del cocinado. Toque cualquier tecla para detener el sonido.

El horno se apagará automáticamente.



INFORMACIÓN

Durante los primeros 10 minutos del cocinado, usted podrá modificar el peso y el grado de acabado, o programar una hora de finalización del cocinado.

Pasado este tiempo, estos valores quedan fijados y no podrán modificarse.

Para modificar estos valores del cocinado, toque la tecla  y el horno volverá a la pantalla de selección.

Siga los pasos indicados anteriormente.

En cualquier momento del cocinado usted puede:

Modificar la temperatura de cocinado, tocando sobre la tecla . Valide con la tecla .

Programar un aviso. Tocando la tecla .

Modificar la programación de un aviso programado. Tocando la tecla .

Para programar, o modificar una programación, siga las instrucciones del apartado «Programación temporizada del cocinado» que encontrará más adelante en esta guía de uso.

PRECALENTAMIENTO EN VACÍO

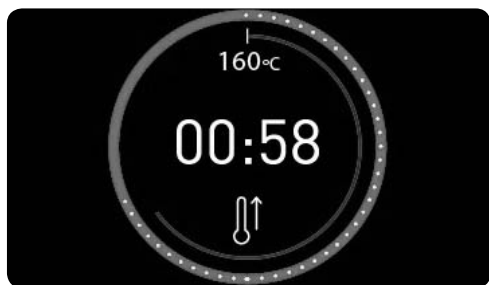



Las recetas indicadas en la tabla con el símbolo , requieren introducir el alimento con el horno ya caliente.

Cuando seleccione una de estas recetas, al iniciar el cocinado se mostrará el símbolo  en la pantalla. Cuando el horno alcance la temperatura de cocinado, el símbolo parpadeará y sonará una alarma para avisar de que ya puede introducir el alimento.

La alarma se apaga automáticamente al abrir la puerta del horno para introducir el alimento, y en la pantalla de cocinado se mostrará el tiempo restante.

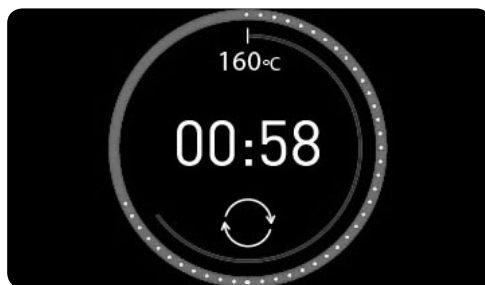
VOLTEO DEL ALIMENTO



Las recetas indicadas en la tabla con el símbolo , requieren dar la vuelta al alimento durante el cocinado.

El horno le avisará cuándo debe hacerlo con una alarma sonora y en la pantalla de cocinado se mostrará el símbolo .

La alarma se apaga automáticamente al abrir la puerta del horno para dar la vuelta al alimento.

Programación temporizada del horno

OPCIONES DE TEMPORIZACIÓN

Usted dispone de las siguientes opciones de temporización para programar un cocinado:

 **Avisador:** Genera una alarma que sonará al terminar el tiempo programado. El cocinado, NO se detendrá cuando acabe el tiempo. También puede generar un aviso cuando el horno no está cocinando.



INFORMACIÓN

Usted puede programar un Aviso, en cualquier momento, independientemente de que el horno esté cocinando o no.

El resto de opciones de temporización, estarán disponibles sólo cuando el horno esté cocinando.

 **Duración del Cocinado:** Permite seleccionar el tiempo que el horno estará cocinando.

Al finalizar el tiempo programada sonará una alarma, el símbolo  parpadeará y el horno dejará de calentar de forma automática.

Toque cualquier tecla para detener la alarma y apagar el horno.

 **Hora de Finalización del Cocinado:** Permite seleccionar la hora hasta la que el horno estará cocinando.

Cuando llegue la hora programada sonará una alarma, el símbolo  parpadeará y el horno dejará de calentar de forma automática.

Toque cualquier tecla para detener la alarma y apagar el horno.

Comienzo de cocinado diferido ( Duración +  Hora de Finalización del Cocinado): Permite programar el horno para que

empiece el cocinado de forma automática y se apague también de forma automática una vez transcurrido el tiempo de cocinado programado.



INFORMACIÓN

Para programar esta opción, deberá programar la Duración y la Hora de Finalización del Cocinado consecutivamente.

Usted podrá acceder a las opciones de programación en cualquier momento de un cocinado.

De la misma forma, podrá acceder a modificar una programación ya establecida.



INFORMACIÓN

Si usted ha seleccionado una receta automática, el horno determinará automáticamente la Duración del cocinado, por lo que esta opción no estará disponible.

En este caso si que podrá:

Programar la Hora de Finalización durante los diez primeros minutos del cocinado.

Programar un aviso en cualquier momento.

PARA PROGRAMAR LAS OPCIONES DE TEMPORIZACIÓN

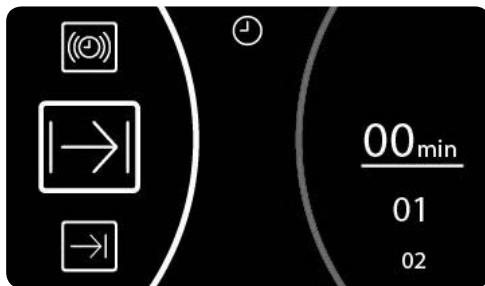

Programación duración del cocinado.

1. Toque sobre la tecla para acceder al menú de opciones de temporización.
2. Gire el mando izquierdo para seleccionar la opción de programación deseada.
3. Gire el mando derecho para seleccionar la duración o la hora de finalización según la opción elegida.



INFORMACIÓN

El horno no permitirá seleccionar una hora de finalización anterior a la hora actual.

Cuando esté programando una hora de finalización, se mostrará en la zona central la hora actual para facilitar la selección.

4. Valide la selección con la tecla .
5. A continuación volverá a mostrarse la pantalla de cocinado. Podrá ver las temporizaciones programadas a la derecha del círculo central.

Funciones de seguridad

BLOQUEO DE SEGURIDAD PARA NIÑOS (BLOQUEO DEL PANEL DE CONTROL)



Esta función se puede activar en cualquier momento:

- **Con el horno apagado.** El bloqueo de niños no permitirá que el horno se encienda al pulsar la tecla .

- **Durante el uso del horno.** Si activa la función mientras el horno está cocinando o en espera, se bloqueará la respuesta del teclado y los mandos y ningún valor de cocinado podrá modificarse.

Para activar la función, toque la tecla de forma prolongada hasta que escuche 1 beep

sonoro y el símbolo  aparezca en la pantalla. El panel de control está bloqueado.

Para desactivar la función, toque de nuevo la tecla  de forma prolongada hasta que escuche 1 beep sonoro y el símbolo  desaparezca.

BLOQUEO MANUAL DE PUERTA

Disponible sólo en modelos pirolíticos.

En los modelos pirolíticos, el bloqueo de seguridad para niños, incluye el bloqueo de la puerta, impidiendo la apertura de la misma.

Para abrir la puerta, debe desactivar el bloqueo de seguridad para niños, siguiendo las instrucciones indicadas anteriormente.



ATENCIÓN

Antes de activar el bloqueo, asegúrese de que la puerta del horno está correctamente cerrada. Si la puerta no está bien cerrada, no se bloqueará, sonará una alarma y en la pantalla parpadeará el símbolo .

Si esto ocurre, cierre bien la puerta para que se detenga el aviso y el bloqueo actúe.

Si no desea bloquear la puerta, desactive el seguro de niños.

Función Teka Hydroclean®

Esta función facilita la limpieza de la grasa y los restos de suciedad que han quedado adheridos en las paredes del horno.

Para una mayor facilidad de limpieza, evite que se acumule la suciedad. Limpie el horno con frecuencia.

PROGRAMAR LA FUNCIÓN TEKA HYDROCLEAN®



ATENCIÓN

No vierta agua en el interior del horno caliente, puede dañar el esmalte de su horno.

Realice siempre el ciclo con el horno frío. Si lo hace con el horno demasiado caliente, el resultado puede verse afectado además de dañar el esmalte.

Retire previamente las bandejas y todos los accesorios del interior del horno, incluidos los soportes para bandejas o guías telescópicas.

Siga para ello las instrucciones que aparecen en el libro de instalación y mantenimiento que se entrega con su horno.

1. Con el horno frío, coloque una bayeta extendida sobre el suelo del horno.

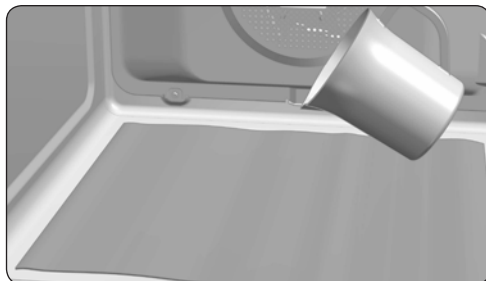



2. Vierta lentamente 200 ml de agua en la parte inferior de la cavidad del horno.



INFORMACIÓN

Para un mejor resultado añada una cucharadita de detergente suave para vajilla en el vaso de agua antes de verterlo sobre la bayeta.

3. Encienda el horno, gire el mando izquierdo para seleccionar la función  y valide con .

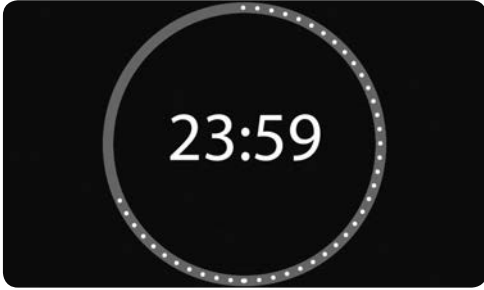

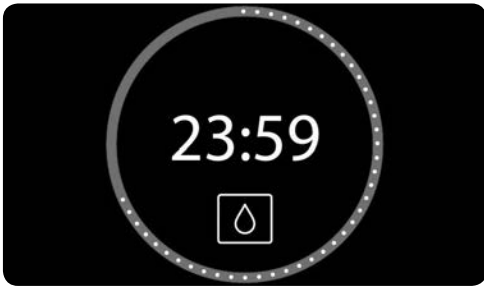

4. A continuación se oirá una señal sonora como confirmación de que la función Teka Hydroclean® se ha puesto en marcha.

En la pantalla se visualizará el símbolo  y el tiempo restante para que finalice la función.



IMPORTANTE

La duración de esta función no se puede modificar. Para finalizar antes de tiempo, apague el horno con la tecla .

5. Alcanzada la hora de finalización, el horno se desconectará, sonará una señal acústica y el símbolo  parpadeará rápidamente.



IMPORTANTE

No abra la puerta del horno hasta que no finalice la función Hydroclean®.

La fase de enfriamiento es necesaria para el correcto funcionamiento de la función.

6. Toque con el dedo cualquier tecla para detener la señal acústica y apagar el símbolo .
7. El horno se apagará automáticamente.
8. El horno está listo para retirar los restos de suciedad y agua sobrante con la bayeta.

La función Hydroclean® se realiza a baja temperatura. No obstante, los tiempos de enfriamiento pueden variar según la temperatura ambiente.



ATENCIÓN

Asegúrese antes de tocar directamente la superficie interior del horno, de que la temperatura es adecuada.

Si tras realizar la función Hydroclean® requiere de una limpieza con más profundidad, utilice detergentes neutros y esponjas no abrasivas.

Función de autolimpieza por pirólisis



ATENCIÓN

Antes de realizar el ciclo de limpieza por pirólisis, lea atentamente las instrucciones de seguridad que encontrará al inicio del libro de Instalación y Mantenimiento.

Esta función le permite realizar un ciclo de limpieza por pirólisis, durante el cual, debido a las altas temperaturas que se alcanzan en el interior del horno se produce un proceso de carbonización de las grasas acumuladas.

En general, se recomienda realizar una pirólisis cada 4-5 cocinados y utilizar el programa más adecuado al nivel de suciedad de su horno. A mayor suciedad, elija un programa de mayor duración.

Durante la pirólisis la iluminación interior del horno permanecerá apagada.

PROGRAMAR LA FUNCIÓN PIRÓLISIS



IMPORTANTE

Antes de realizar la pirólisis es imprescindible retirar todos los accesorios y vajilla del horno, incluyendo los soportes de bandejas y/o guías telescópicas. Siga para ello las instrucciones que aparecen en el libro de instalación y mantenimiento que se entrega con su horno.



ATENCIÓN

Retire del interior cualquier derrame o resto excesivo de suciedad, ya que durante la pirólisis podrían inflamarse corriendo peligro de incendio.



ATENCIÓN

Antes de poner en marcha la pirólisis, asegúrese de que la puerta del horno está correctamente cerrada.

1. Encienda el horno y seleccione la función Pirólisis  girando el mando izquierdo.

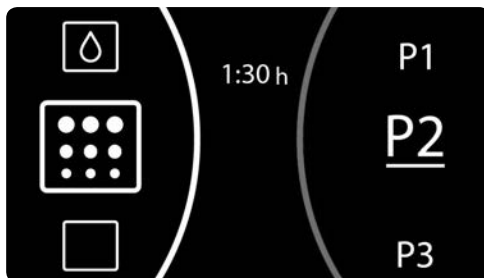

2. Con el mando derecho, seleccione el programa de pirólisis más adecuado al nivel de suciedad de su horno:

P1: Pirólisis suave. Duración 1 hora.

P2: Pirólisis normal. Duración 1 hora y 30 min.

P3: Pirólisis intensiva. Duración 2 horas.

3. Valide la selección con la tecla . Inmediatamente después, comenzará el bloqueo automático de puerta.



ATENCIÓN

Si la puerta no está bien cerrada, la pirólisis no comenzará. Sonará una alarma y en la pantalla parpadeará el símbolo .

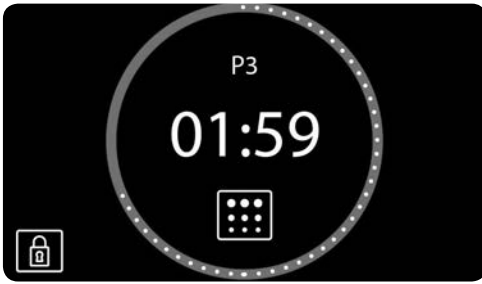

Si esto ocurre, cierre bien la puerta para que el bloqueo actúe y pueda comenzar la pirólisis.

4. Cuando la puerta esté bloqueada, se iluminará el símbolo  en la pantalla del reloj y se mostrará el tiempo restante para la finalización de la pirólisis.



IMPORTANTE

El horno está programado y realizando el ciclo de limpieza pirólítica.

Durante los primeros 10 minutos podrá retrasar el comienzo de la pirólisis, programando la hora de finalización de la misma. Para ello, toque la tecla  para acceder al menú de opciones de temporización. Una vez seleccionada la hora de finalización válida con la tecla .

Durante la pirólisis no se puede seleccionar ninguna otra opción de temporización. Sí que podrá activar el bloqueo de seguridad para niños, si así lo desea.

Tampoco intente abrir la puerta del horno ya que podría interrumpir el proceso de limpieza.

5. Cuando finaliza la limpieza pirólítica, escuchará una señal acústica, el símbolo  parpadeará y verá 00:00 en la pantalla.

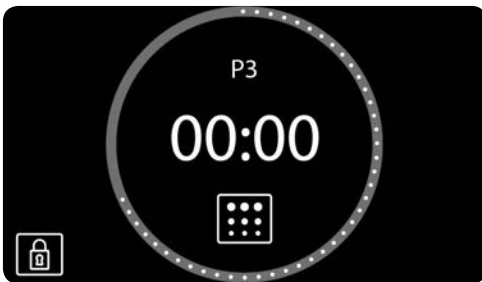

6. Pulse cualquier tecla del reloj para detener la señal acústica.
7. El horno se apagará automáticamente.
8. El proceso de calentamiento del horno ha finalizado, sin embargo el horno está excesivamente caliente y no puede ser utilizado.

Hasta que el horno no se enfríe la refrigeración continúa funcionando y el símbolo  permanece iluminado.



IMPORTANTE

Debido a las altas temperaturas en el interior del horno, el tiempo de enfriamiento puede variar en función de la temperatura ambiente.

9. Una vez que su horno se haya enfriado el símbolo  se apagará y la puerta quedará desbloqueada.
10. Abra la puerta del horno y pase un paño húmedo por el interior de la cavidad, retirando la ceniza producida durante el ciclo de limpieza. En zonas de difícil acceso del interior del horno será necesario limpiar con algún estropajo de fibra no metálica.
11. Una vez limpio el interior del horno, no olvide instalar de nuevo los soportes y sus accesorios.
12. El horno ya está preparado para un nuevo cocinado.



IMPORTANTE

Si detecta alguna incidencia en la programación y manejo de esta función consulte la guía de instalación y mantenimiento incluida en su horno.

CANCELACIÓN DE LA PIRÓLISIS

La pirólisis es una función automática y como tal, sólo puede accionarse mediante la programación del reloj. Para cancelar una pirólisis en curso es necesario desprogramar el horno, siguiendo estas instrucciones:

1. Pulse la tecla .

La pirólisis se detendrá.

2. En función de la temperatura del interior del horno pueden darse estas dos situaciones:

- a) Temperatura del interior peligrosa: En este caso, la puerta permanecerá bloqueada hasta que la temperatura llegue a valores seguros. En la pantalla se mostrará el símbolo .

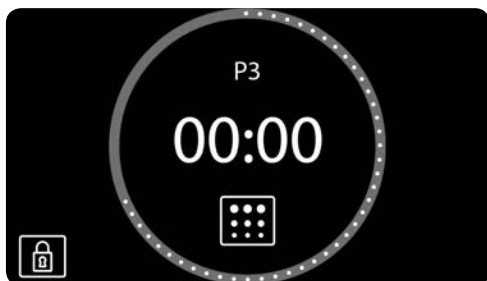

Una vez que la puerta está desbloqueada y pueda abrirse, desaparecerá el símbolo  y se mostrará de nuevo la hora en la pantalla del reloj.

- b) Temperatura del interior segura: Si la temperatura del interior del horno es segura, el desbloqueo se realizará inmediatamente.
3. Temperatura del interior segura: Si la temperatura del interior del horno es segura, el desbloqueo se realizará inmediatamente y el horno volverá a la pantalla de reposo.

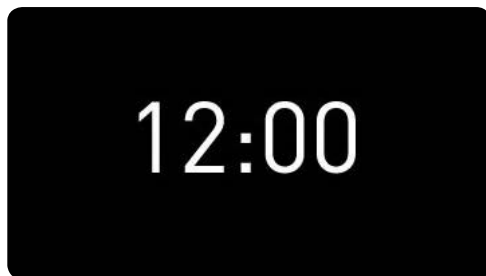

Descrição do forno

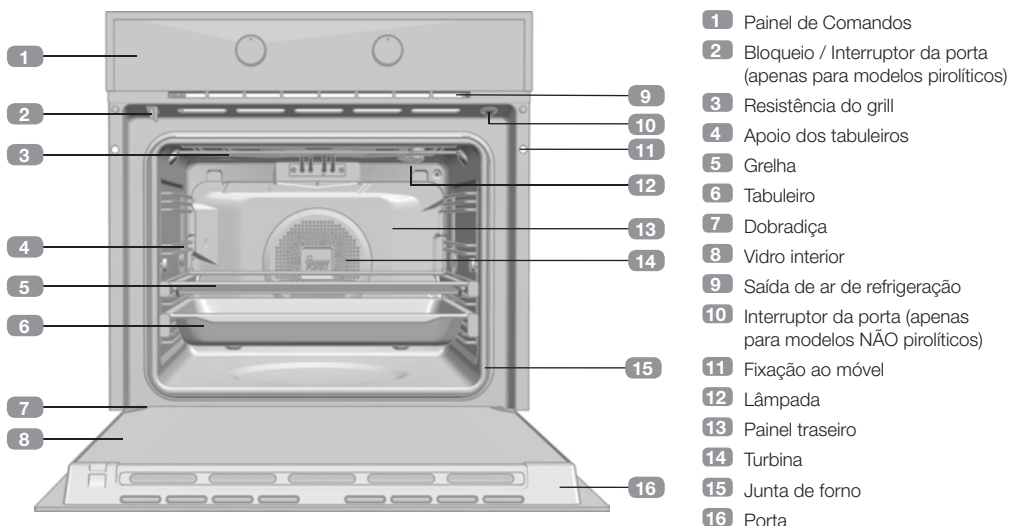

Painel de comandos

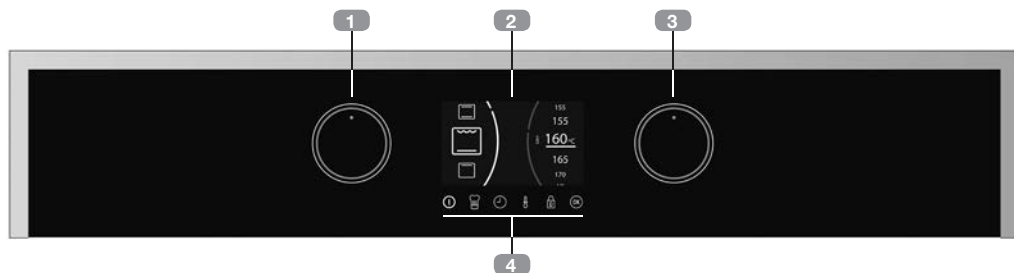

1 Comando para tocar nos menus da parte esquerda do ecrã. Seletor de funções de cozinhado.

2 Ecrã de visualização.

3 Comando para navegar nos menus da parte direita do ecrã. Seletor de ajustes de cozinhado.

4 Teclas.

 **Ligar / desligar o forno.**

 **Acesso ao assessor pessoal de cozinhado (PCA)**

 **Acesso às funções de temporizador e programação do forno.**

 **Alteração da temperatura do forno.**

 **Ativação/desativação do bloqueio do teclado/da porta, de acordo com os modelos.**

 **Tecla de validação. Ligar/desligar a luz interior.**

Ligar e acertar a hora

Ao ligar o forno pela primeira vez, aparecerá o logótipo seguido da indicação 12:00 a piscar.

Para poder trabalhar com o forno, é necessário acertar a hora no relógio.

Para isso, seleccione as horas com o comando esquerdo e os minutos com o comando direito.

Valide a seleção com a tecla  ou aguarde uns segundos.

Como confirmação, ouvirá um sinal sonoro e a hora aparecerá fixa no ecrã.

Para alterar a hora:

Com o forno em repouso (ecrã inicial), mantenha a tecla  pressionada até que a hora comece a piscar. Siga os passos indicados para alterar a hora.



ATENÇÃO

A sensibilidade das teclas touch adapta-se continuamente às condições ambientais. Ao ligar o forno à corrente, é necessário ter o cuidado de garantir que a superfície do vidro da parte da frente dos comandos está limpa e livre de qualquer obstáculo.



Se, ao tocar no vidro, o ecrã não responder corretamente, é necessário desligar o forno da corrente elétrica e voltar a ligá-lo alguns segundos depois. Desta forma, os sensores ajustar-se-ão automaticamente e reagirão de novo ao tocar com o dedo.

FUNÇÃO DEMO (Função especial para exposições)

Com a função DEMO ativada, pode usar o forno sem aquecer.

É recomendável ativar esta função quando o forno é instalado numa exposição com ligação à corrente.

Ativação da função DEMO

Antes de acertar o relógio, clique em simultâneo nas teclas  e , até que no ecrã apareça a indicação «DEMO Mode ON».

A seguir acerte a hora no forno.

A palavra «DEMO» aparecerá de forma permanente no ecrã e o forno pode trabalhar normalmente, mas sem aquecer.

Para desativar a função DEMO, deve desligar o forno da corrente.



ATENÇÃO

No caso de um corte de corrente elétrica, será apagada toda a programação do relógio eletrónico.

Aparecerá a indicação 12:00.

Pode seguir as instruções anteriores para acertar a hora do relógio.

Se o forno estava com a porta aberta antes do corte de energia, o símbolo de bloqueio acende-se até que a porta desbloqueie.

Isto pode demorar alguns minutos, dependendo da temperatura a que se encontrava o forno, e durante esse tempo não é possível acertar o relógio.

Assim que a porta se desbloquear, poderá acertar o relógio seguindo as instruções anteriores.



Descrição do ecrã de controlo

A seguir descrevemos a informação que encontrará no ecrã de visualização do seu forno e como se apresenta.

ECRÃ INICIAL / REPOUSO

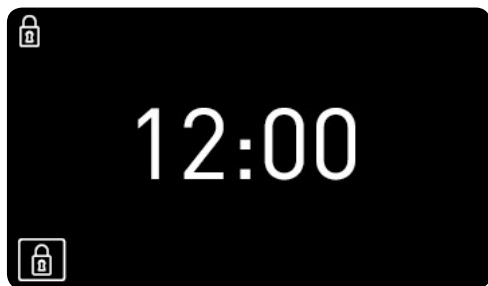
Este ecrã aparecerá quando o forno não estiver a funcionar, mas estiver ligado à corrente.



Se o bloqueio do teclado ou da porta estiverem ativos, os símbolos  e  aparecem na parte esquerda do ecrã.

Se houver um aviso programado, o ecrã deixa de mostrar a hora e mostra a contagem decrescente, conforme apresentado na imagem seguinte.

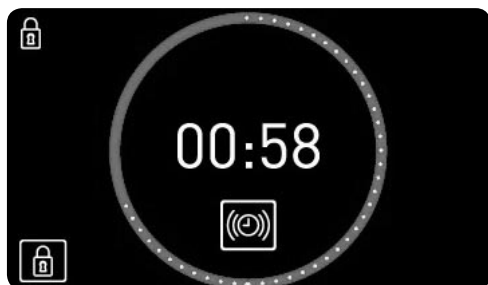

ECRÃ DE SELEÇÃO



Seleção de função.

Enquanto seleciona a função de cozinhado, receita automática ou função do relógio, o ecrã aparece dividido em dois setores:

SETOR ESQUERDO. Nesta zona do ecrã aparecem as funções de cozinhado, as receitas automáticas ou as funções de programação do relógio disponíveis para seleção.

Para selecionar qualquer uma delas, gire o comando esquerdo até que a função desejada apareça aumentada e valide a seleção com a tecla  (se não selecionar nenhuma tecla, alguns segundos depois o forno validará a seleção automaticamente).

SETOR ESQUERDO. Nesta zona do ecrã aparecem os valores que se podem ajustar de acordo com a função selecionada: temperatura, peso, duração, hora de finalização, ...

Para selecionar um valor, gire o comando direito até que o valor desejado apareça aumentado e valide a seleção com a tecla  (se não selecionar nenhuma tecla, alguns segundos depois o forno validará a seleção automaticamente).

ECRÃ DE COZINHADO

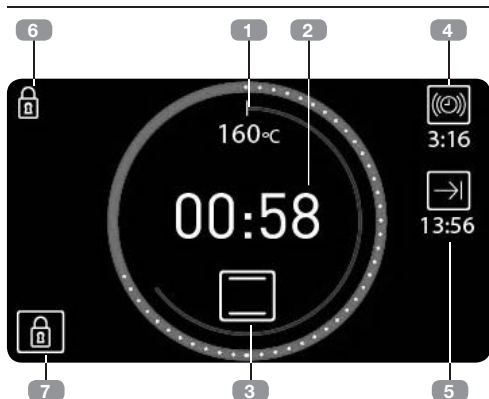

Durante o cozinhado, a informação sobre a situação do forno aparece no ecrã organizada em torno dos círculos centrais:

Círculo interior de temperatura. A vermelho. Representa, em escala, a temperatura selecionada.

Círculo exterior de tempo.

- A vermelho quando mostra o tempo que o forno está a cozinhar. Aparecerá um ponto branco a cada 2 minutos.
- A azul quando mostra o tempo que falta para que o cozinhado finalize (contagem decrescente). Desaparecerá um ponto branco a cada 2 minutos.

Dentro destes círculos, encontrará a seguinte informação sobre o cozinhado:

1. Temperatura selecionada. O símbolo °C piscará até que se alcance a temperatura selecionada e sempre que o forno esteja a transmitir calor ao alimento.

2. Duração do cozinhado.

- Se não programou o relógio, aparecerá o tempo a que o forno está a cozinhar e a circunferência do tempo será vermelha.
- Se fez alguma programação, mostrará o tempo que falta para que o cozinhado finalize (contagem decrescente) e a circunferência do tempo será azul.
- Se o forno não está programado e está em modo de espera (ainda não começou a cozinhar), aparecerá a duração total do cozinhado programado.

3. Função de cozinhado ou receita automática selecionada.

Fora dos círculos, encontrará a seguinte informação sobre as funções adicionais:

ZONA DIREITA DO ECRÃ Se programou funções de tempo, a informação referente a estas funções aparece na zona direita do ecrã.

4.  Avisador. Faz a contagem decrescente para a finalização do aviso programado.

5.  Hora de Finalização.

ZONA ESQUERDA DO ECRÃ Informação sobre as Funções de segurança ativadas.

6.  Bloqueio do teclado. Iluminar-se-á quando o bloqueio de segurança para crianças estiver ativado.

7.  Bloqueio da porta: APENAS NOS MODELOS PIROLÍTICOS. Iluminar-se-á quando o bloqueio manual da porta estiver ativado.

Cozinhado com funções tradicionais

FUNÇÕES DO FORNO



INFORMAÇÃO

Para obter uma descrição da utilização de cada uma das funções, consulte o guia de cozinhados fornecido com o seu forno.



DESLIGAR



CONVENCIONAL 



CONVENCIONAL COM TURBINA 



GRILL E RESISTÊNCIA INFERIOR 



MAXIGRILL



GRILL



RESISTÊNCIA INFERIOR 



PIZZA 



TURBO 

ECO ECO



A LUME BRANDO



FERMENTAR MASSAS



DESCONGELAÇÃO



HYDROCLEAN



PIRÓLISE (de acordo com o modelo)



Funções que incorporam pré-aquecimento rápido automático

PARA COZINHAR COM AS FUNÇÕES TRADICIONAIS



Seleção de função.

Ligue o forno premindo a tecla .

Gire o comando esquerdo até que a função desejada apareça aumentada.

A seguir, aparecerá à direita a temperatura recomendada para a função escolhida.



Se desejar, pode alterar a temperatura ao girar o comando direito.

Valide a seleção com a tecla .

O forno começará a cozinhar.

A qualquer momento durante o cozinhado pode:

- **Alterar a função de cozinhado** girando o comando esquerdo.

- **Modificar a temperatura do cozinhado** girando o comando direito.
- **Programar um aviso ou uma duração/hora de término do cozinhado.** Premindo a tecla .
- **Alterar a programação de avisos ou duração/hora de término programados.** Premindo a tecla .



INFORMAÇÃO

Para programar ou modificar uma programação, consulte a secção «Programação temporizada do cozinhado», que encontrará mais adiante neste guia de utilização.

PRÉ-AQUECIMENTO RÁPIDO AUTOMÁTICO

































As funções assinaladas incorporam pré-aquecimento rápido automático.

Durante o pré-aquecimento rápido, o símbolo  ilumina-se.

Recomendamos que não coloque os alimentos até que o símbolo se apague.

COZINHADO COM ASSESSOR PESSOAL DE COZINHADO (PCA)

RECEITAS AUTOMÁTICAS DO FORNO

AVES		 FRANGO	
		 PATO	
		 GANSO	
		 PERU	
		 PERNAS	
CARNES		 LEITÃO	
		 BOI	
		 BORREGO	
		 COSTELETAS	
PEIXES		 PESCADA	
		 SALMÃO	
PÃO		 PÃO BRANCO	
		 PÃO DE MISTURA	
		 PÃO INTEGRAL	
PIZZAS		 PIZZA COM MASSA ALTA	
		 PIZZA COM MASSA FINA	
SOBREMESAS		 BOLO DE FORMA	
		 BOLO DE FRUTAS GRANDE	
		 BOLO DE FRUTAS PEQUENO	
		 BOLO EM TABULEIRO	

 Receitas que requerem o pré-aquecimento do forno em vazio.

 Receitas que requerem dar a volta ao alimento.

PARA COZINHAR COM O ASSESSOR PESSOAL DE COZINHADO

Ligue o forno premindo a tecla .

Prima a tecla .



Seleção de receita.

Gire o comando esquerdo até que o tipo de alimento que pretende cozinhar apareça aumentado.

A seguir, no setor direito do ecrã, aparecerão as receitas disponíveis para o tipo de alimento selecionado. Selecione com o comando direito a receita desejada e valide a seleção com a tecla .

A seguir, no setor direito do ecrã, aparecerá a informação que o forno precisa para programar o cozinhado.

De acordo com a receita selecionada, o forno pedirá que indique:

PESO DO ALIMENTO: selecione com o comando direito e valide com a tecla .

TEMPERATURA: valide a temperatura proposta pela receita ou selecione outra com o comando direito e confirme com a tecla .

TIPO DE ACABADO: em alguns cozinhados, pode selecionar o tipo de acabamento:

- **HIGH:** acabamento bem passado
- **MEDIUM:** acabamento no ponto
- **LOW:** acabamento mal passado

Uma vez selecionados todos os parâmetros, valide com a tecla .

O forno começará a cozinhar e o ecrã de seleção dará lugar ao ecrã de cozinhado, onde poderá ver a seguinte informação:

- Temperatura de cozinhado selecionada
- Tempo de cozinhado em falta
- Receita selecionada

Uma vez concluído o cozinhado, soará um alarme sonoro durante cerca de 90 segundos e no ecrã o símbolo de cozinhado ficará a piscar. Prima qualquer tecla para parar o som.

O forno apagar-se-á automaticamente.



INFORMAÇÃO

Durante os primeiros 10 minutos do cozinhado, poderá alterar o peso e tipo de acabamento ou programar uma hora de finalização do cozinhado.

Decorrido este tempo, os valores ficam fixos e não poderão ser alterados.

Para alterar estes valores de cozinhado, prima a tecla  e o forno voltará ao ecrã de seleção.

Siga os passos indicados anteriormente.

A qualquer momento durante o cozinhado pode:

Alterar a temperatura do cozinhado, premindo a tecla . Valide com a tecla .

Programar um aviso. Premindo a tecla .

Alterar a programação de um aviso programado. Premindo a tecla .

Para programar, ou alterar uma programação, siga as instruções da secção «Programação temporizada do cozinhado», que encontrará mais adiante neste guia de utilização.

PRÉ-AQUECIMENTO EM VAZIO:

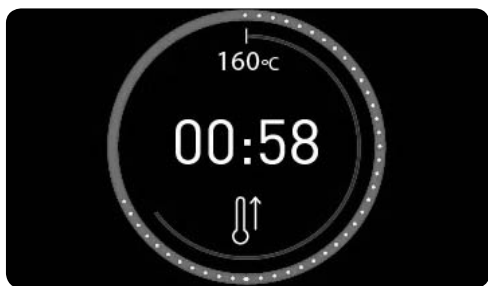



As receitas indicadas na tabela com o símbolo  requerem colocar o alimento com o forno já aquecido.

Quando selecionar uma destas receitas, ao começar o cozinhado, aparecerá o símbolo  no ecrã. Quando o forno atingir a temperatura de cozinhado, o símbolo pisca e soa um alarme para avisar que já pode colocar o alimento.

O alarme desliga-se automaticamente ao abrir a porta do forno para colocar o alimento e no ecrã de cozinhado aparece o tempo restante.

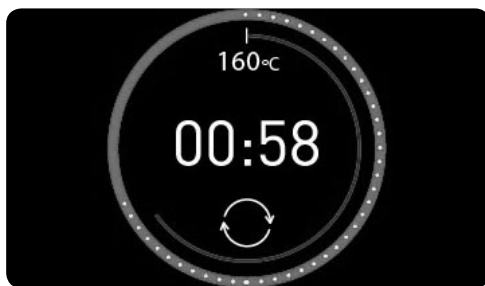
DAR A VOLTA AOS ALIMENTOS



As receitas indicadas na tabela com o símbolo  requerem dar a volta ao alimento durante o cozinhado.

O forno avisá-lo-á quando o deve fazer com um alarme sonoro e, no ecrã de cozinhado, aparecerá o símbolo .

O alarme desliga-se automaticamente ao abrir a porta do forno para dar a volta ao alimento.

PROGRAMAÇÃO TEMPORIZADA DO FORNO

OPÇÕES DE TEMPORIZAÇÃO

Dispõe das seguintes opções de temporização para programar um cozinhado:

 **Avisador:** criar um alarme para soar ao finalizar o tempo programado. O cozinhado NÃO termina quando termina o tempo. Também pode criar um aviso para quando o forno não está a cozinhar.



INFORMAÇÃO

Pode programar um Aviso, em qualquer momento, independentemente do forno estar ou não a cozinhar.

As restantes opções de temporização só estão disponíveis quando o forno estiver a cozinhar.

 **Duração do Cozinhado:** permite selecionar o tempo que o forno vai estar a cozinhar.



Finalizado o tempo programado, soará um alarme, o símbolo  piscará e o forno deixará de aquecer de forma automática.

Prima qualquer tecla para parar o alarme e desligar o forno.

 **Hora de Finalização do Cozinhado:** permite selecionar a hora até à qual o forno estará a cozinhar.

Ao chegar à hora programada, soará um alarme, o símbolo  piscará e o forno deixará de aquecer de forma automática.

Prima qualquer tecla para parar o alarme e desligar o forno.

Início do cozinhado guardado ( **Duração** +  **Hora de Finalização do Cozinhado**): Permite programar o forno para que comece o

cozinhado de forma automática e se desligue também de forma automática, uma vez transcorrido o tempo de cozinhado programado.



INFORMAÇÃO

Para programar esta opção, deverá programar consecutivamente a Duração e a Hora de Finalização do Cozinhado.

Poderá aceder às opções de programação em qualquer momento do cozinhado.

Da mesma forma, poderá alterar uma programação já estabelecida.



INFORMAÇÃO

Se seleccionou uma receita automática, o forno determinará automaticamente a Duração do cozinhado, pelo que esta opção não estará disponível.

Porém, neste caso poderá:

Programar a Hora de Finalização durante os primeiros dez minutos do cozinhado.

Programar em qualquer momento um aviso.

PARA PROGRAMAR AS OPÇÕES DE TEMPORIZAÇÃO

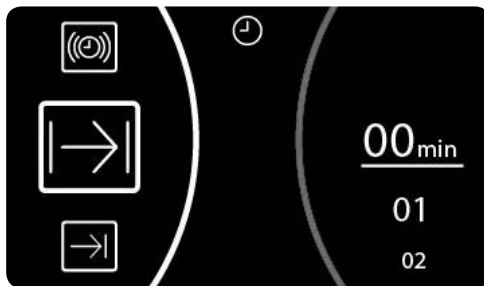

Programação duração do cozinhado

1. Prima a tecla  para aceder ao menu de opções de temporização.
2. Gire o comando esquerdo para seleccionar a opção de programação desejada.
3. Gire o comando direito para seleccionar a duração ou a hora de finalização de acordo com a opção escolhida.



INFORMAÇÃO

O forno não permitirá seleccionar uma hora de finalização anterior à hora atual.

Quando a hora de finalização estiver programada, aparecerá na zona central a hora atual para facilitar a seleção.

4. Valide a seleção com a tecla .
5. A seguir, voltará a aparecer o ecrã de cozinhado. Poderá ver as temporizações programadas à direita do círculo central.



Funções de segurança



BLOQUEIO DE SEGURANÇA PARA CRIANÇAS (BLOQUEIO DO PAINEL DE CONTROLO)

Esta função pode ser ativada a qualquer momento:

- **Com o forno apagado.** O bloqueio para crianças não permitirá que o forno seja ligado ao premir a tecla .

- **Durante o uso do forno.** Se ativar a função enquanto o forno cozinha ou está em espera, ficará bloqueada a resposta do teclado e dos comandos e nenhum valor do cozinhado se poderá alterar.

Para ativar a função, prima a tecla  prolongadamente até que soe 1 sinal sonoro e o símbolo  seja apresentado no visor. O painel de controlo está bloqueado.

Para desativar a função, prima de novo a tecla  prolongadamente até que soe 1 sinal sonoro e o símbolo  desapareça.

BLOQUEIO MANUAL DA PORTA

Disponível apenas nos modelos pirolíticos.

Nos modelos pirolíticos, o bloqueio de segurança para crianças inclui o bloqueio da porta, o que impede a abertura da mesma.

Para abrir a porta, deve desativar o bloqueio de segurança para crianças seguindo as instruções indicadas anteriormente.



ATENÇÃO

Antes de ativar o bloqueio, confirme que a porta do forno está corretamente fechada. Se a porta não estiver bem fechada, não bloqueará, soará um alarme e piscará o símbolo  no ecrã.

Caso isso aconteça, feche bem a porta para que o aviso termine e o bloqueio comece.

Se não deseja bloquear a porta, desative a segurança para crianças.

Função Teka Hydroclean®

Esta função facilita a limpeza de gordura e restos de sujidade que tenham aderido às paredes do forno.

Para facilitar a limpeza, evite a acumulação de sujidade. Limpe frequentemente o forno.

PROGRAMAR A FUNÇÃO TEKA HYDROCLEAN®



ATENÇÃO

Não verta água no interior do forno ainda quente, pois poderá danificar o esmalte do mesmo.

Realize sempre o ciclo com o forno frio. Se o procedimento for efetuado com o forno demasiado quente, poderá haver alterações no resultado e poderá danificar o esmalte.

Retire previamente os tabuleiros e todos os acessórios do interior do forno, incluindo os suportes dos tabuleiros ou as guias telescópicas.

Para tal, siga as instruções presentes no manual de instalação e manutenção fornecido com o forno.

1. Com o forno frio, coloque um pano estendido na base do forno.

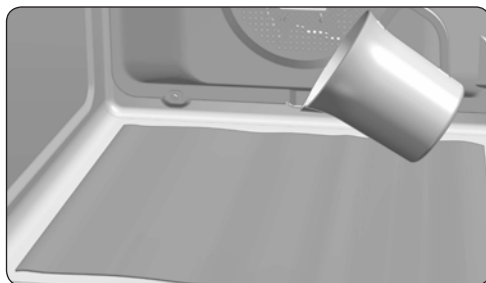



2. Verta lentamente 200 ml de água na parte inferior da cavidade do forno.



INFORMAÇÃO

Para melhores resultados, adicione uma colher de sobremesa de detergente suave para a loiça no copo de água antes de o verter no pano.

3. Ligue o forno, gire o comando esquerdo para seleccionar a função  e valide com .

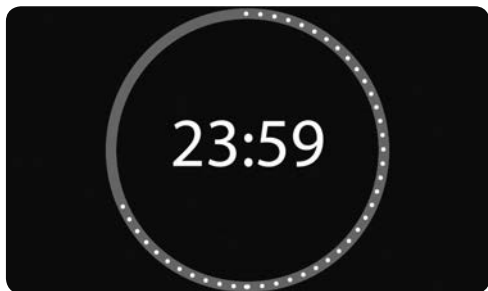

4. A seguir ouvirá um sinal sonoro que confirma que a função Teka Hydroclean® já começou. No ecrã, será apresentado o símbolo  e o tempo restante para que termine a função.

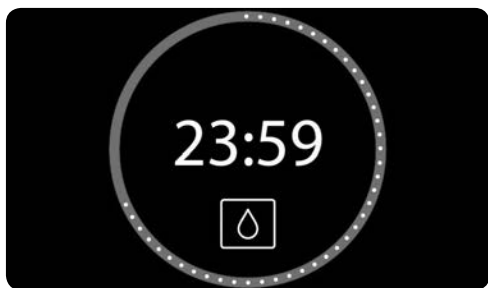

IMPORTANTE

Não é possível alterar a duração desta função. Para terminar antes, desligue o forno com a tecla .

5. Assim que for atingida a hora de finalização, o forno desligar-se-á, será emitido um sinal sonoro e o símbolo  piscará rapidamente.



IMPORTANTE

Não abra a porta do forno até que a função Hydroclean® finalize.

A fase de arrefecimento é necessária para o correto funcionamento da função.

6. Prima qualquer tecla com o dedo para parar o sinal sonoro e apagar o símbolo .
7. O forno apagar-se-á automaticamente.
8. O forno está pronto para retirar os restos de sujidade e a restante água com o pano.

A função Hydroclean® é realizada a baixa temperatura. No entanto, o tempo de arrefecimento pode variar de acordo com a temperatura ambiente.



ATENÇÃO

Antes de tocar diretamente na superfície interior do forno, certifique-se de que este se encontra a uma temperatura adequada.

Se após a realização da função Hydroclean® for necessária uma limpeza mais profunda, utilize detergentes neutros e esponjas não abrasivas.

Função de autolimpeza por pirólise



ATENÇÃO

Antes de realizar o ciclo de limpeza por pirólise, leia atentamente as instruções de segurança disponibilizadas no início do manual de Instalação e Manutenção.

Esta função permite-lhe realizar um ciclo de limpeza por pirólise, durante o qual se produz um processo de carbonização das gorduras acumuladas, devido às elevadas temperaturas que são atingidas no interior do forno.

Em geral, recomenda-se a realização de uma pirólise a cada 4 ou 5 cozinhados e a utilização do programa mais adequado ao nível de sujidade do seu forno. Em caso de maior sujidade, escolha um programa de maior duração.

Durante a pirólise, a iluminação do forno permanecerá apagada.

PROGRAMAR A FUNÇÃO PIRÓLISE



IMPORTANTE

Antes de realizar a pirólise é imprescindível retirar todos os acessórios e loiça do forno, incluindo os suportes de tabuleiros e/ou guias telescópicas. Para tal, siga as instruções presentes no manual de instalação e manutenção fornecido com o forno.



ATENÇÃO

Retire quaisquer líquidos derramados ou restos excessivos de sujidade do interior, uma vez que, durante o processo de pirólise, estes podem inflamar-se e aumentar o risco de incêndio.



ATENÇÃO

Antes de dar início ao programa de pirólise, certifique-se de que a porta do forno está devidamente fechada.

1. Ligue o forno e selecione a função de pirólise  girando o comando esquerdo.

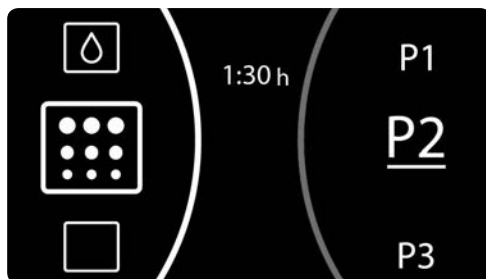

2. Com o comando direito, selecione o programa de pirólise mais adequado ao nível de sujidade do forno:

P1: Pirólise suave. Duração 1 hora.

P2: Pirólise normal. Duração 1 hora e 30 min.

P3: Pirólise intensiva. Duração 2 horas.

3. Valide a seleção com a tecla . O bloqueio automático da porta será ativado de imediato.



ATENÇÃO

A pirólise não começará se a porta não estiver bem fechada. Soará um alarme e no ecrã piscará o símbolo .

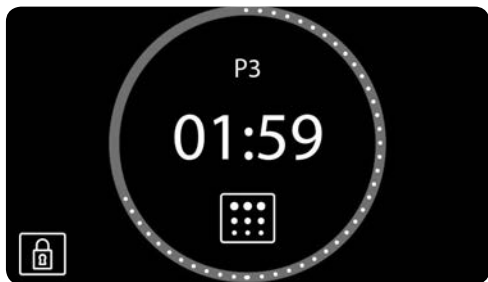

Neste caso, feche bem a porta para que o bloqueio atue e a pirólise possa começar.

4. Quando a porta estiver bloqueada, iluminar-se-á o símbolo  no ecrã do relógio e será apresentado o tempo restante para a finalização da pirólise.



IMPORTANTE

O forno está programado e a realizar o ciclo de limpeza pirolítica.

Durante os primeiros 10 minutos, poderá atrasar o começo da pirólise, programando a hora de finalização da mesma. Para isso, prima a tecla  para aceder ao menu de opções de temporização. Uma vez selecionada a hora de finalização, valide com a tecla .

Durante a pirólise não é possível selecionar outra opção de temporização. Mas, se quiser, poderá ativar o bloqueio de segurança para crianças.

Não deve tentar abrir a porta do forno, pois poderá interromper o processo de limpeza.

- Quando a limpeza pirolítica estiver finalizada, ouvirá um sinal sonoro, o símbolo  piscará e será apresentada a indicação 0:00 no ecrã.

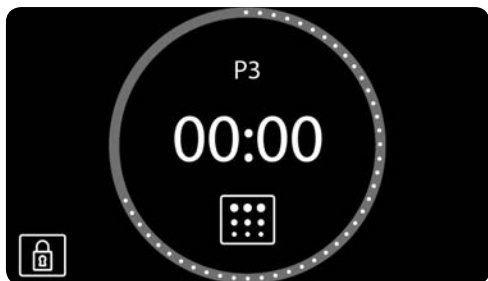

- Prima qualquer tecla do relógio para parar o sinal sonoro.
- O forno desligar-se-á automaticamente.
- O processo de aquecimento do forno finalizou, no entanto, o forno está excessivamente quente e não pode ser utilizado.

A refrigeração continua a funcionar até que o forno arrefeça e o símbolo  permanece acesso.



IMPORTANTE

Devido às altas temperaturas no interior do forno, o tempo de arrefecimento pode variar de acordo com a temperatura ambiente.

- Assim que o forno tiver arrefecido, o símbolo  apagar-se-á e a porta ficará desbloqueada.
- Abra a porta do forno e passe um pano humedecido pelo interior da cavidade, retirando a cinza produzida durante o ciclo de limpeza. Em zonas de difícil acesso do interior do forno, será necessário limpar com um esfregão de fibra não metálica.
- Quando o interior do forno estiver limpo, não se esqueça de voltar a colocar os suportes e os seus acessórios.
- O forno está preparado para um novo cozinhado.



IMPORTANTE

Caso detete algum problema durante a programação ou manuseio desta função, consulte o guia de instalação e manutenção fornecido com o seu forno.

CANCELAMENTO DA PIRÓLISE

A pirólise é uma função automática e, como tal, só pode ser acionada através da programação do relógio. Para cancelar um processo de pirólise em curso, é necessário desprogramar o forno, seguindo estas instruções:

1. Prima a tecla ①.

A pirólise é interrompida.

2. Dependendo da temperatura do interior do forno, podem ocorrer estas duas situações:

- a) Temperatura do interior perigosa: neste caso, a porta permanecerá bloqueada até que a temperatura atinja valores seguros. No ecrã aparecerá o símbolo .

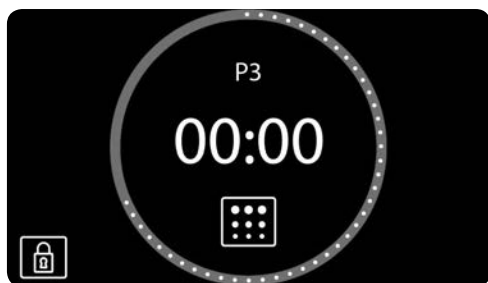

Assim que a porta se encontre desbloqueada e seja possível abri-la, desaparecerá o símbolo  e a hora será novamente apresentada no ecrã do relógio.

- b) Temperatura do interior segura: se a temperatura do interior do forno for segura, o desbloqueio realizar-se-á imediatamente.
3. Temperatura do interior segura: se a temperatura do interior do forno for segura, o desbloqueio realizar-se-á de imediato e o forno regressará ao ecrã de repouso.

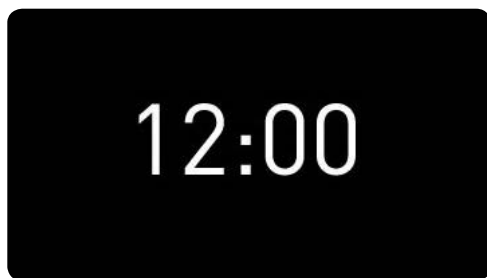

Description of the oven

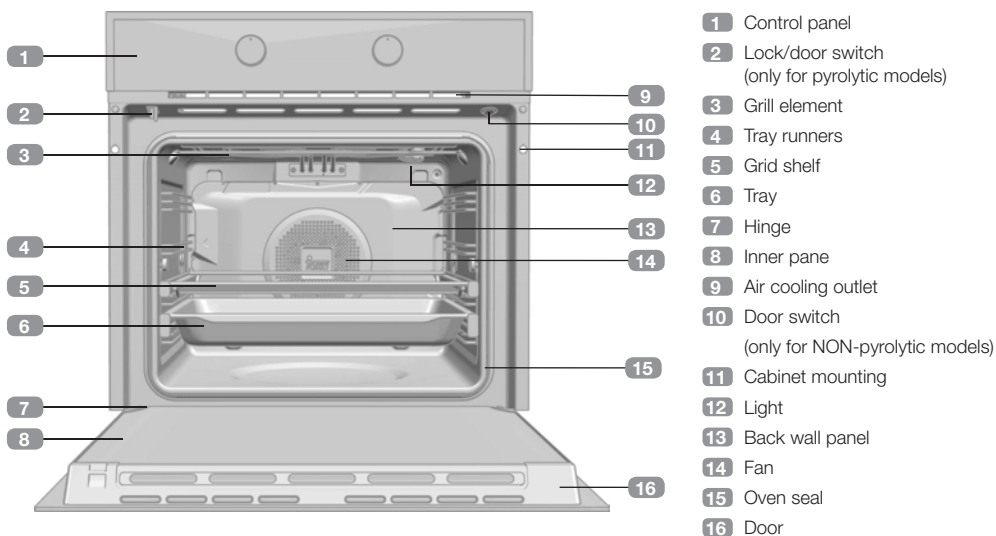

Control Panel

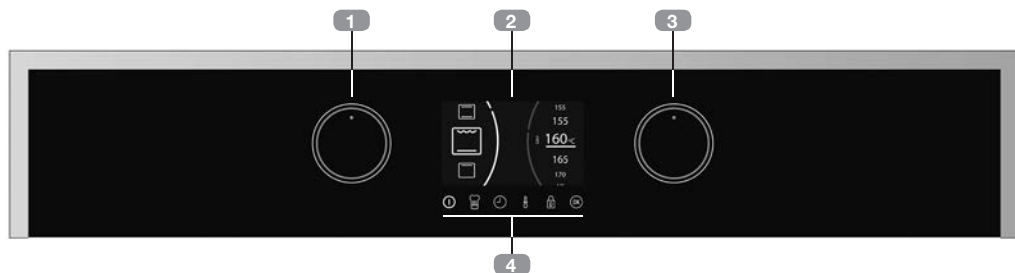

1 Dial to scroll through the menus on the left side of the screen. Cooking mode dial.

2 Display screen.

3 Dial to scroll through the menus on the right side of the screen. Cooking settings dial.

4 Keys.

 **Switching the oven On/Off.**

 **Access to the Personal Cooking Assistant (PCA)**

 **Access to the timing and programming settings.**

 **Altering the oven temperature.**

 **Activation / Deactivation of the keypad / door lock depending on the model.**

 **Confirm button. Switching the inner light on/off.**

Switching on and setting the time

When plugging the oven in for the first time, the logo will appear followed by 12:00 flashing on the screen.

You must set the time in order to use the oven.

To do this select the hour with the left control and the minutes with the right one.

Confirm the settings by pressing the  button or waiting a few seconds.

An audible signal will be heard confirming that the time has been set on the screen.

To change the time:

With the oven in standby (start screen), hold the  button until the time begins to flash. Follow these steps to change the time:



WARNING

The sensitivity of the touch controls continuously adapt to the ambient conditions. Make sure the glass surface of the control panel is clean and free of any obstacles when plugging in the oven.



If the clock does not respond correctly when you touch the glass, unplug the oven for a few seconds and then plug it in again. Doing this causes the sensors to adjust automatically and they will react again to finger touch.

DEMO MODE (Special function for shop floors)

With the DEMO mode activated, you can control the oven without heating.

Activating this mode is recommended if the oven is to be plugged in at a showroom.

Activating DEMO mode

Before setting the clock, press the   simultaneously until “DEMO Mode ON” appears on the screen.

Then, set the time on the oven.

The word “DEMO” will be shown permanently on the panel and the oven will work as normal, but without heating up.

To deactivate DEMO mode, unplug the oven from the socket.



WARNING

In the event of a power failure, your electronic clock/timer settings will be erased.

The time 12:00 will appear.

You can set the time as described above.

If the oven door was locked before the power cut, the locked symbol will appear until it is unlocked.

This may take several minutes, depending on the temperature inside the oven, and during this period you cannot reset the time.

Once the door is unlocked, you can set the time as described above.



Description of the control panel

Information that you will find on the display screen of your oven and how this will be displayed is outlined below.

START SCREEN/STANDBY

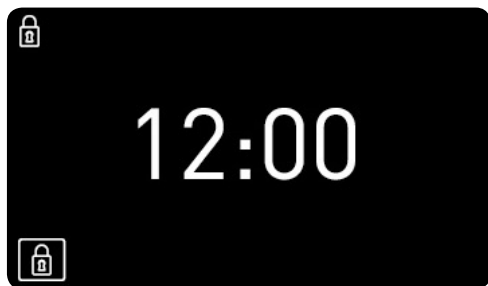
This screen will appear when the oven is not working, but is still plugged in.



If the keypad or door locks are activated, the  and  symbols will appear on the left side of the screen.

If a timer has been programmed, the screen will stop showing the time and show a countdown, as can be seen in the image.

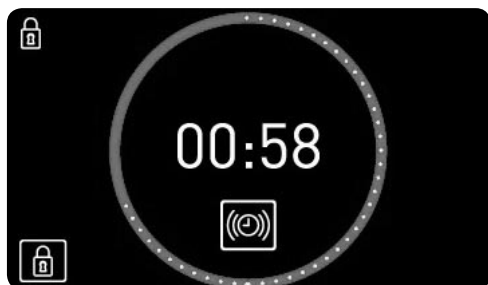

SELECTION SCREEN



Selecting functions.

When selecting a cooking function, automatic recipe or timer programme the screen will be split into two sections:

LEFT SECTION. This part of the screen shows available cooking settings, automatic recipes and timer programmes.

To select any one of these, turn the left dial until the desired function appears and confirm the selection with the button  (if you do not press any buttons, the oven will confirm this automatically after a few seconds).

RIGHT SECTION. This part of the screen shows the values that can be set according to the selected mode: temperature, weight, duration, finish time...

To select a value, turn the right dial until the desired value appears and confirm the selection with the button  (if you do not press any buttons, the oven will confirm this automatically after a few seconds).

COOKING INFORMATION SCREEN

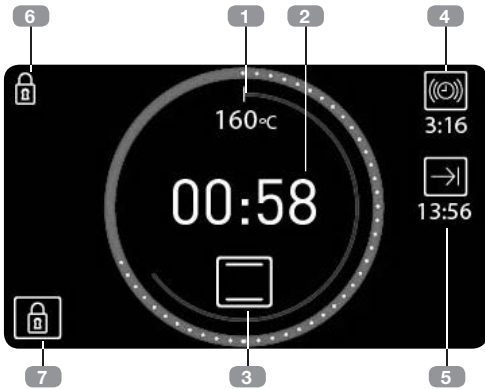

During cooking, the information on the oven's status will appear on the screen around two central circles:

Inner temperature circle. In red. Represents the selected temperature on a scale.

Outer time circle.

- When showing how long the food has been cooking, the circle is red. A white dot will appear every 2 minutes.
- When showing how much time is left for the cooking time to finish (countdown), the circle is blue. A white dot will disappear every 2 minutes.

Inside these circles the following cooking information is shown:

1. Selected temperature. The symbol °C will flash until the selected temperature is reached and whenever the oven is transmitting heat to the food.

2. Cooking time.

- If the timer has not been programmed, the elapsed cooking time will be shown and a red circle will appear around the time.
- If the timer has been set, the time left until cooking ends (countdown) will be shown and the circle will be blue.
- If the oven has been programmed, but is set to delay (cooking has not yet started), the total programmed cooking time will be shown.

3. Cooking settings or automatic recipe selection.

Outside of the circles, the following information on additional settings is shown:

RIGHT SIDE OF THE SCREEN. If time settings have been programmed, information relevant to these is shown on the right side of the screen.

4.  Timer. Countdown with audible signal to indicate the cooking time has finished.

5.  Finish time.

LEFT SIDE OF THE SCREEN. Information on activated safety settings.

6.  Keypad lock. The child-safety lock will light up when activated.

7.  Door lock. ONLY FOR PYROLYTIC MODELS. Will light up when the manual door lock is activated.















Traditional cooking functions

OVEN FUNCTIONS



INFORMATION

For a description of the use of each of these functions, please consult the cooking guide included with your oven.

-  **ON / OFF BUTTON**
-  **CONVENTIONAL** 
-  **CONVENTIONAL WITH FAN** 
-  **GRILL AND BOTTOM HEAT** 
-  **MAXIGRILL**
-  **GRILL**
-  **BOTTOM HEAT** 
-  **PIZZA** 
-  **TURBO** 
- ECO ECO**
-  **SLOW COOKING**
-  **RISING DOUGH**
-  **DEFROSTING**
-  **HYDROCLEAN**
-  **PYROLYSIS (according to model)**

 **Settings with fast preheating**

COOKING WITH TRADITIONAL FUNCTIONS



Selecting functions.

Turn the oven on by pressing the **ⓘ** button.

Turn the left dial until the desired function has been reached.

The recommended temperature for the function chosen will then appear on the right.

If desired, the temperature can be changed by turning the right dial.

Confirm your choice with the **OK** button.

The oven will begin cooking.

At any time during the cooking process you can:

- **Change the cooking function** by turning the left dial.

- **Change the cooking temperature** by turning the right dial.
- **Programme the cooking timer or a duration /finish time** by pressing the **⌚** button.
- **Modify programmed timers or duration /finish times** by pressing the **⌚** button.



INFORMATION

To set or modify a programme, consult the “Timed cooking programmes” section which can be found further on in this users manual.

AUTOMATIC FAST PREHEATING

































The functions indicated incorporate fast preheating.

During fast preheating the **⌚** symbol lights up.

We recommend waiting until this symbol goes away before putting in the food.

Cooking with the Personal Cooking Assistant (PCA)

AUTOMATIC OVEN RECIPES

POULTRY		 CHICKEN	
		 DUCK	
		 GOOSE	
		 TURKEY	
		 DRUMSTICKS	
MEAT		 SUCKLING PIG	
		 BEEF	
		 LAMB	
		 CHOPS	
FISH		 HAKE	
		 SALMON	
BREAD		 WHITE BREAD	
		 BROWN BREAD	
		 WHOLEMEAL BREAD	
PIZZA		 THICK CRUST	
		 THIN CRUST	
DESSERTS		 CAKES IN A MOULD	
		 LARGE FRUITCAKE	
		 SMALL PIE	
		 CAKES ON TRAYS	

 Recipes that require preheating the oven while empty.

 Recipes that require turning the food.

COOKING WITH THE PERSONAL COOKING ASSISTANT

Turn the oven on by pressing  button. Tap the  button.



Recipe selection.

Turn the left dial until the type of food that you want to cook is shown.

Available recipes for the selected food type will appear on the left side of the screen. With the right dial select the desired recipe and confirm it with the  button.

Then, on the right section of the screen, the information that the oven needs to programme the cooking will appear.

Depending on the recipe selected, the oven will ask you to key in:

THE WEIGHT OF THE FOOD: Select with the right dial and confirm with the  button.

THE TEMPERATURE: Confirm the suggested temperature for the recipe or select another with the right dial and confirm with the  button.

LEVEL OF BROWNNESS: For some recipes, you can select the finish:

- **HIGH:** Well browned
- **MEDIUM:** Medium browned
- **LOW:** Lightly browned

When all settings have been chosen, confirm with the  button.

The oven will start cooking and the cooking screen will appear in place of the selection screen, showing the following information:

- Selected cooking temperature
- Remaining cooking time
- Recipe selected

When the cooking time has finished an audible signal will sound for approximately 90 seconds and the cooking symbol will flash on the screen. Press any button to turn off the audible signal.

The oven will turn off automatically.



INFORMATION

In the first 10 minutes of cooking, you will be able to change the weight and level of brownness, or set a finish time.

After this time, these settings will be set and cannot be changed.

To change these cooking settings, tap the button  and the oven will revert to the selection screen.

Follow the instructions above.

At any time during the cooking process you can:

Change the cooking temperature by touching the button . Confirm with the  button.

Set the timer by pressing the  button.

Change the existing timer by pressing the  button.

To set or modify a programme, consult the “Timed cooking programmes” section which can be found further on in this user manual.

PREHEATING WHILE EMPTY

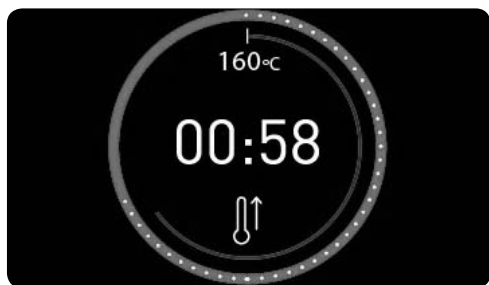



For recipes indicated in the table by the symbol , the oven must be preheated before any food is put in.

When you select one of these recipes, the  symbol will appear on the screen as cooking begins. When the oven reaches the cooking temperature, the symbol will flash and an audible signal will sound to notify you that the food can now be put into the oven.

When the door is opened to put in the food the audible signal will switch off automatically, and the remaining time will show on the cooking screen.

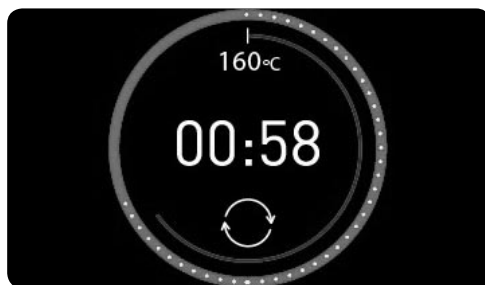
TURNING FOOD



For recipes indicated in the table by the symbol , food must be turned during cooking.

The oven will notify you when to do this with an audible signal and the  symbol will appear on the cooking screen.

Opening the oven door to turn the food will cause the audible signal to turn off automatically.

Oven timer settings

TIMER OPTIONS

You can use the following timer options to programme cooking:

 **Timer:** An audible signal will sound when the programmed time finishes. Cooking will NOT stop when the timer sounds. The timer can also be set when the oven is not cooking.



INFORMATION

You can set a timer at any time regardless of whether or not the oven is cooking.

The rest of the timer options are available only when the oven is cooking.

 **Cooking Time:** Allows you to select for how long the oven will cook.

An audible signal will sound at the end of the programmed time, the  symbol will flash and the oven will stop heating automatically.

Tap any button to stop the audible signal and turn the oven off.

 **Cooking Finish Time:** Allows you to set the time for when the oven will stop cooking.

An audible signal will sound when the set time is reached, the  symbol will flash and the oven will stop heating automatically.

Tap any button to stop the audible signal and turn the oven off.

Starting delayed cooking ( Cooking Duration +  Finish Time): Allows you to

programme the oven to start cooking automatically and switch off automatically once the programmed time has ended.



INFORMATION

To programme this option, set the Cooking Duration and Finish Time consecutively.

You can access the programming options at any time during cooking.

Similarly, you can change an existing programme.



INFORMATION

If you have chosen an automatic recipe, the oven will automatically determine the cooking time so this option will not be available.

However, you can:

Programme the Finish Time during the first ten minutes of cooking.

Set the timer at any time.

PROGRAMMING THE TIMER OPTIONS

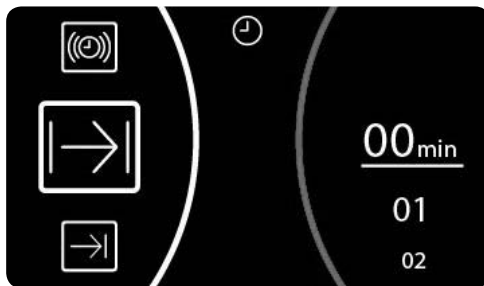

Programming during cooking.

1. Press the  button to access the timer options menu.
2. Turn the left dial to select the desired programme option.
3. Turn the right dial to choose the duration or finish time depending on the chosen option.



INFORMATION

The oven will not allow you to select a finish time before the time it is now.

When programming a finish time, the centre section will show the current time to help you choose.

4. Confirm your choice with the  button.
5. The cooking screen will then be shown again. You will be able to see programmed timers to the right of the central circle.

Safety instructions

CHILD SAFETY LOCK (CONTROL PANEL LOCK)



This feature can be activated at any time:

- **With the oven switched off.** The child lock will not allow the oven to be switched on when the  button is touched.

- **With the oven in use.** If the feature is activated while the oven is cooking or set to delay, the keypad will not respond and it will not be possible to use the dials or change the cooking settings.

To activate this feature press and hold the  button until you hear a beep and the symbol

 appears on the screen. The control panel is now locked.

To deactivate this feature touch and hold the  button again until you hear a beep and the  symbol disappears.

LOCKING THE DOOR MANUALLY

Only available for pyrolytic models.

For pyrolytic models, the child safety lock includes a door lock which prevents it from being opened.

To open the door, the child safety lock must be deactivated following the above-mentioned instructions.

Teka Hydroclean® function

This feature helps to clean any grease and other deposits from the sides of the oven.

Avoid letting deposits build up to make cleaning easier. Clean the oven often.

PROGRAMMING THE TEKA HYDROCLEAN® FUNCTION



WARNING

Do not pour water into the hot oven as this can damage the enamel.

Always run the cycle when the oven is cold. Results may be affected if you do so while the oven is too hot and in addition can damage the enamel.

First remove the trays and all accessories from inside the oven, including the tray runners and telescopic guide rails.



WARNING

Before activating the lock, be sure that the oven door is closed properly. If the door is not properly closed, it will not lock, an audible signal will sound and the symbol will flash on the screen .

If this happens, close the door until the warning disappears and the lock works.

If you do not want to lock the door, deactivate the child safety lock.

To clean these, follow the instructions in the Installation and Maintenance booklet that comes with your oven.

1. With the oven cold, spread a cloth on the bottom of the oven.

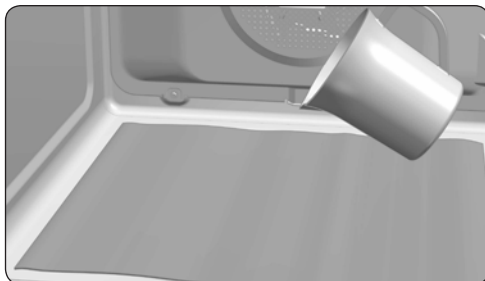



2. Slowly pour 200 ml of water onto the bottom of the oven.



INFORMATION

For best results, add a teaspoon of mild washing-up detergent to a glass of water before pouring it onto a cloth.

3. Switch the oven on, turning the left dial to select the  function and confirm with the  button.

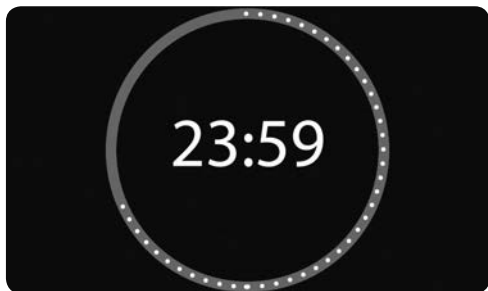

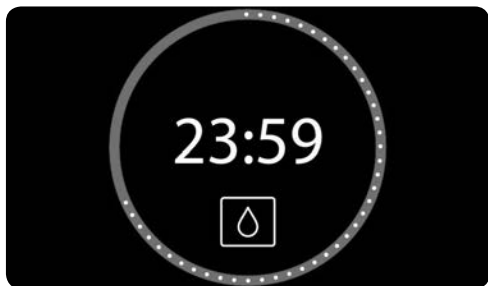

4. An audible signal will be heard confirming that the Teka Hydroclean® feature has been activated.

On the screen the  symbol will appear as will the remaining time the cycle needs to finish.



IMPORTANT

The duration of this cycle cannot be changed. To stop before the completion of the cycle, turn the oven off by pressing the button .

5. When the cycle ends, the oven will turn itself off, an audible signal will sound and the  symbol will flash quickly.



IMPORTANT

Do not open the oven door until the Hydroclean® cycle has ended completely.

The cooling cycle is necessary for this feature to work properly.

6. Press any button with your fingertip to stop the audible signal and to turn off the  symbol.
7. The oven will turn off automatically.
8. The oven is ready for dirt deposits and excess water to be removed with the cloth.

The Hydroclean® feature works at low temperatures. However, cooling times can vary according to room temperature.



WARNING

Before touching the inner surface of the oven directly, make sure that the temperature is not too hot.

If a deeper clean is required after running the Hydroclean® feature, use neutral detergents and non-abrasive sponges.

Pyrolytic self-cleaning function



WARNING

Before carrying out the pyrolytic cleaning cycle, carefully read the safety instructions found at the beginning of the Installation and Maintenance booklet.

This feature allows you to run the pyrolytic cleaning cycle during which built-up grease deposits are burned off by the high temperatures inside the oven.

Generally, a pyrolytic cycle is recommended after every 4-5 uses; choose the most suitable programme depending on how dirty your oven is. For very dirty ovens, choose a longer cycle.

During the pyrolytic cycle the light inside the oven will remain off.

PROGRAMMING THE PYROLYTIC FUNCTION



IMPORTANT

Before carrying out the pyrolytic cleaning cycle, remove all accessories and dishes from the oven, including the shelf runners and/or telescopic guide rails. To clean these follow the instructions in the Installation and Maintenance booklet that comes with your oven.



WARNING

Clean any spillages or excess dirt, as during the pyrolytic cleaning cycle these can ignite and become a fire hazard.



WARNING

Before running the pyrolytic cycle, ensure that the oven is properly closed.

1. Turn the oven on and select the Pyrolysis  feature using the left dial.

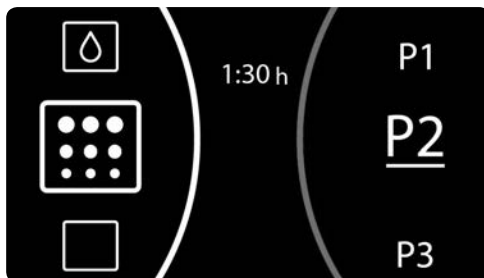

2. Use the right dial to choose the most suitable pyrolytic programme depending on how dirty your oven is:

P1: Gentle pyrolysis. Lasts 1 hour.

P2: Medium pyrolysis. Lasts 1.5 hours.

P3: Intensive pyrolysis. Lasts 2 hours.

3. Confirm your choice with the  button. Immediately afterwards, the door will lock automatically.



WARNING

If the door is not properly closed, the pyrolysis cycle will not begin. An audible signal will sound and the symbol will flash on the screen .

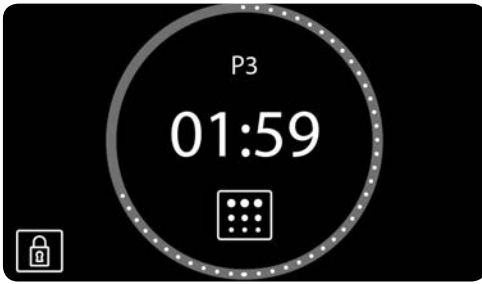

If this occurs, close the door properly to activate the lock and start the pyrolytic cycle.

4. When the door is locked the  symbol will light up on the clock display and the time remaining until the end of the cycle will be shown.



IMPORTANT

The oven is programmed and the pyrolytic cleaning cycle is under way.

In the first 10 minutes you can delay the start of the pyrolysis by programming an end time. To do so, press the button  to access the timer options menu. Once the end time has been selected confirm it using the button .

During the pyrolytic cycle you cannot select a different timer option. If you wish, you can activate the child safety lock.

Do not try to open the oven door as this may interrupt the cleaning process.

5. When the pyrolytic cleaning cycle ends, an audible signal will sound, the  symbol will flash and 00:00 will appear on the screen.

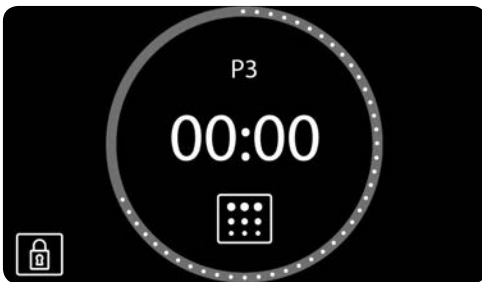

6. Press any key to disable the audible signal.
7. The oven will turn off automatically.
8. The oven's heating process has ended, however the oven is extremely hot and cannot be used.

The cooling motor will operate and the  symbol will remain on until the oven cools down.



IMPORTANT

The cooling process may vary according to room temperature because of the high temperatures inside the oven.

9. Once your oven has cooled the  symbol will go off and the door will unlock.
10. Open the oven door and wipe the inside with a damp cloth, cleaning up the ash produced during the cleaning cycle. Hard-to-reach areas in the oven will need to be cleaned with a non-metal fibre scourer.
11. Once the oven is clean, do not forget to replace the runners and accessories.
12. The oven is now ready to be used again.



IMPORTANT

If you have any problems with the programming and use of this feature, consult the Installation and Maintenance booklet included with your oven.

CANCELLING THE PYROLYSIS

Pyrolysis is an automatic function and as such, can only be activated using the timer programme. To cancel the pyrolysis the oven has to be reset, following the instructions below:

1. Press the  button.

The pyrolysis will stop.

2. Two situations can arise in relation to the inside temperature of the oven:

a) Dangerous inside temperature: In this case, the door will remain locked until the temperature falls to a safe level. The  symbol will appear on the screen.

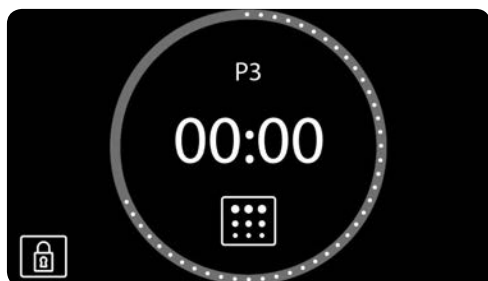

When the door is unlocked and can be opened, the  symbol will disappear and the time will be shown again on the clock display.

- b)** Safe inside temperature: If the inside temperature of the oven is safe, it will unlock immediately.
3. Safe inside temperature: If the inside temperature of the oven is safe, it will unlock immediately and the oven will revert to the standby screen.

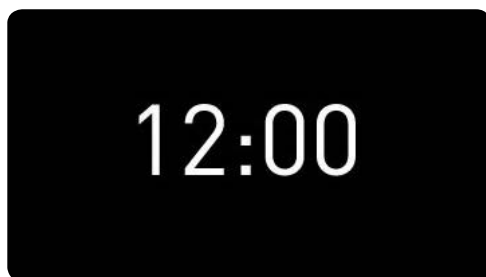

Description du four

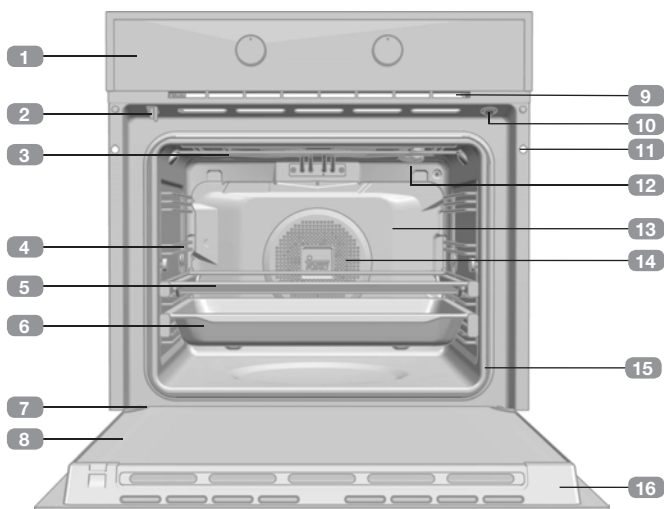





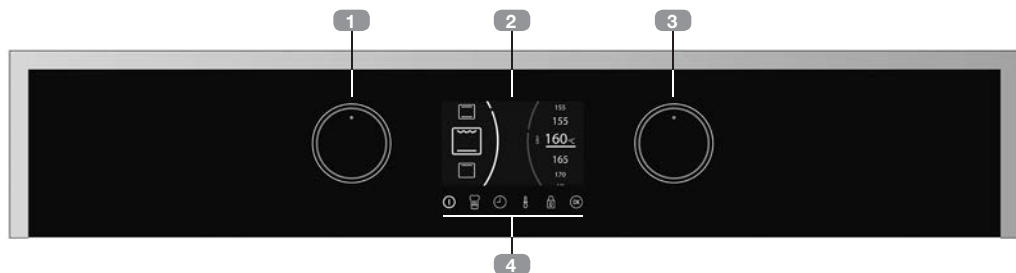

- 1 Panneau de commande
- 2 Verrouillage / interrupteur de porte (pour les modèles à pyrolyse uniquement)
- 3 Résistance du grill
- 4 Supports plaques
- 5 Grille
- 6 Plaque
- 7 Charnière
- 8 Vitre intérieure
- 9 Sortie d'air de refroidissement
- 10 Interrupteur de porte uniquement pour les modèles SANS PYROLYSE
- 11 Fixation au meuble
- 12 Ampoule
- 13 Panneau du fond
- 14 Turbine
- 15 Joint de four
- 16 Porte

Panneau frontal des commandes



- 1 Commande pour parcourir les menus de la partie gauche de l'écran. Sélecteur de modes de cuisson.
- 2 Écran d'affichage.
- 3 Commande pour parcourir les menus de la partie droite de l'écran. Sélecteur des réglages de cuisson.
- 4 Touches.

- | | |
|--|---|
|  Allumage/ Arrêt du four. |  Modification des températures du four. |
|  Accès à l'assistant personnel de cuisson (APC) |  Activation/désactivation du verrouillage du clavier / porte selon les modèles. |
|  Accès aux fonctions de minuterie et de programmation du four. |  Touche de validation. Arrêt / Allumage de la lumière intérieure. |

Allumage et réglage de l'heure

Lorsque vous branchez le four pour la première fois au secteur, le logo apparaît suivi de l'indication clignotante 12:00.

Pour pouvoir utiliser le four, il est nécessaire de mettre l'horloge à l'heure.

Pour cela, sélectionnez les heures avec la commande de gauche et les minutes avec la commande de droite.

Validez la sélection avec la touche  ou attendez quelques secondes.

Un signal sonore est émis pour confirmer et l'heure se fixe sur l'écran.

Pour modifier l'heure :

Avec le four en veille (écran d'accueil), maintenez la touche  enfoncée jusqu'à ce que l'heure se mette à clignoter. Suivez les étapes décrites pour modifier l'heure.



MISE EN GARDE

La sensibilité des touches tactiles s'adapte constamment aux conditions ambiantes. Lorsque vous branchez le four au secteur électrique, veillez à ce que la surface vitrée du tableau de commande soit propre et sans aucun obstacle.



Si l'écran ne répond pas correctement lorsque vous touchez la vitre avec le doigt, il faut débrancher le four du secteur électrique et le rebrancher après un court instant. Ceci permet de régler automatiquement les capteurs qui réagiront de nouveau lorsque vous toucherez les commandes tactiles.

MODE DEMO (Fonction spéciale pour les expositions)

Lorsque le mode DEMO est activé, le four peut être utilisé sans qu'il ne chauffe.

Il est recommandé d'activer ce mode si le four va être installé dans une exposition tout en étant branché au secteur.

Activation du mode DÉMO

Avant de mettre l'horloge à l'heure, appuyez simultanément sur les touches  et , jusqu'à ce que l'indication «DEMO Mode ON» s'affiche à l'écran.

Mettez ensuite le four à l'heure.

Le mot «DEMO» reste affiché à l'écran et le four peut fonctionner normalement. Cependant, il ne chauffera pas.

Pour désactiver le mode DÉMO, vous devez débrancher le four du secteur.



MISE EN GARDE

En cas de coupure de courant, toute la programmation de l'horloge électronique est annulée.

L'indication 12:00 apparaîtra.

Vous pourrez mettre l'horloge à l'heure en suivant les instructions précédentes.

Si la porte du four était verrouillée avant la coupure de courant, le symbole de verrouillage s'allumera jusqu'à ce que la porte se déverrouille.

Cela peut prendre plusieurs minutes en fonction de la température du four ; pendant ce temps, vous ne pourrez pas mettre l'horloge à l'heure.

Une fois la porte déverrouillée, vous pourrez mettre l'horloge à l'heure en suivant les instructions précédentes.



Description de l'écran de contrôle

Veillez trouver ci-dessous la description de l'information s'affichant sur l'écran d'affichage de votre four et de la façon dont elle s'affiche.

ÉCRAN D'ACCUEIL / VEILLE

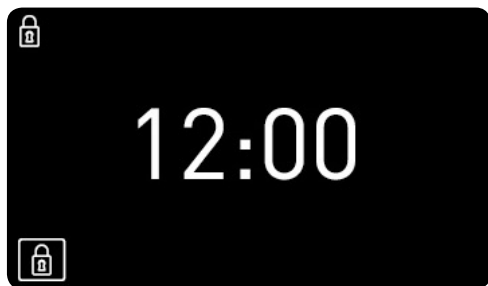
Cet écran apparaît lorsque le four ne fonctionne pas mais qu'il est branché au secteur.



Si le verrouillage du clavier ou celui de la porte est activé, les symboles  et  s'affichent sur la partie gauche de l'écran.

Si vous avez programmé une alarme, l'écran affiche un compte à rebours à la place de l'heure, comme sur l'image suivante.

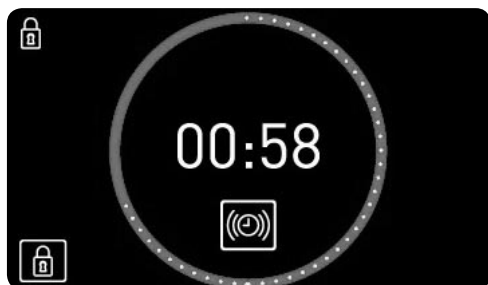

ÉCRAN DE SÉLECTION



Sélecteur de fonction.

Pendant la sélection d'une fonction de cuisson, d'une recette automatique ou de la fonction d'horloge, l'écran apparaît divisé en deux parties :

PARTIE GAUCHE. Dans cette partie de l'écran se trouvent les fonctions de cuisson, les recettes automatiques ou les fonctions de programmation de l'horloge disponibles pour leur sélection.

Pour en sélectionner une, tournez la commande de gauche jusqu'à ce que la fonction souhaitée apparaisse en plus grand et validez la sélection avec la touche  (si vous ne touchez à rien, le four valide la sélection automatiquement après quelques secondes).

PARTIE DROITE. Dans cette partie de l'écran se trouvent les valeurs à régler en fonction du mode sélectionné : température, poids, durée, heure de fin, ...

Pour sélectionner une valeur, tournez la commande de droite jusqu'à ce que la valeur souhaitée apparaisse en plus grand et validez la sélection avec la touche  (si vous ne touchez à rien, le four valide la sélection automatiquement après quelques secondes).

ÉCRAN DE CUISSON

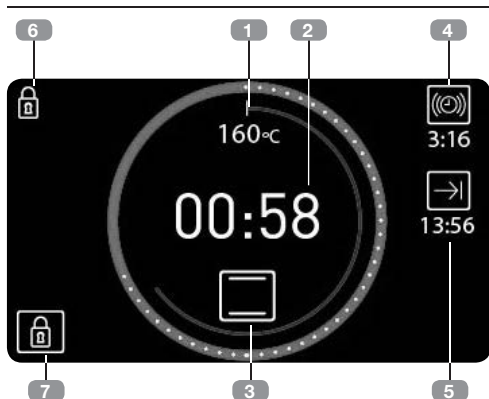

Pendant la cuisson, l'information sur l'état du four s'affiche à l'écran, organisée autour de deux cercles centraux :

Le cercle intérieur de température. En rouge. Il représente, à l'échelle, la température sélectionnée.

Le cercle extérieur de temps.

- En rouge lorsqu'il montre le temps que le four a passé en pleine cuisson. Un point blanc apparaît toutes les 2 minutes.
- En bleu lorsqu'il montre le temps qu'il reste pour que la cuisson se termine (compte à rebours). Un point blanc disparaît toutes les 2 minutes.

Dans ces cercles, vous trouvez l'information suivante sur la cuisson :

1. Température sélectionnée. Le symbole °C clignote jusqu'à ce que la température sélectionnée est atteinte et à condition que le four transmette de la chaleur à l'aliment.

2. Durée de cuisson.

- Si vous n'avez pas programmé l'horloge, il indique le temps que le four a passé en pleine cuisson et le cercle de temps s'affiche en rouge.
- Si vous l'avez programmé, il indique le temps qu'il reste pour que la cuisson se termine (compte à rebours) et le cercle de temps s'affiche en bleu.
- Si le four est programmé mais en attente (la cuisson n'a pas commencé), il indique le temps de cuisson total programmé.

3. Fonction de cuisson ou recette automatique sélectionnée.

Hors des cercles, vous trouvez l'information suivante sur les fonctions supplémentaires :

PARTIE DROITE DE L'ÉCRAN. Si vous avez programmé des fonctions de temps, l'information relative à ces fonctions se trouve dans la partie droite de l'écran.

4.  Avertisseur. Compte à rebours pour la fin de l'alarme programmée.

5.  Heure de fin.

PARTIE GAUCHE DE L'ÉCRAN. Information sur les fonctions de sécurité activées.

6.  Verrouillage du clavier. S'illumine lorsque le verrouillage de sécurité pour les enfants est activé.

7.  Verrouillage de la porte. POUR LES MODÈLES À PYROLYSE UNIQUEMENT. S'illumine lorsque le verrouillage manuel de porte est activé.

Cuisson avec des fonctions traditionnelles

FONCTIONS DU FOUR



INFORMATION

Consultez le guide de cuisson fourni avec votre four pour connaître l'utilisation détaillée de chacune des fonctions.



DÉCONNEXION



CUISSON TRADITIONNELLE ⏸



CUISSON TRADITIONNELLE

À TURBINE ⏸



GRIL ET SOLE ⏸



MAXI GRIL



GRIL



SOLE ⏸



PIZZA ⏸



TURBO ⏸

ECO MODE ECO



CUISSON À FEUX DOUX



FERMENTATION DE PÂTES



DÉCONGÉLATION



HYDROCLEAN



PYROLYSE (selon le modèle)



Fonctions intégrant un préchauffage rapide automatique

POUR CUISINER AVEC LES FONCTIONS TRADITIONNELLES



Sélecteur de fonction.

Allumez le four en appuyant sur la touche .

Tournez la commande de gauche jusqu'à ce que la fonction souhaitée apparaisse en plus grand.

La température recommandée pour la fonction choisie s'affiche ensuite à droite.



Si vous le souhaitez, vous pouvez modifier la température en tournant la commande de droite.

Validez la sélection avec la touche .

Le four commence la cuisson.

À tout moment de la cuisson, vous pouvez :

- **Changer la fonction de cuisson**, en tournant la commande de gauche.

- **Modifier la température de cuisson** en tournant la commande de droite.
- **Programmer une alarme ou une durée/heure de fin de cuisson.** En appuyant sur la touche .
- **Modifier la programmation des alarmes ou de la durée/heure de fin programmée.** En appuyant sur la touche .



INFORMATION

Pour programmer ou modifier une programmation, consultez le paragraphe « Programmation de cuisson avec minuterie » que vous trouverez plus loin dans ce guide d'utilisation.

PRÉCHAUFFAGE RAPIDE AUTOMATIQUE

































Les fonctions indiquées intègrent un préchauffage rapide automatique

Pendant le préchauffage rapide, le symbole  s'allume.

Il est recommandé d'attendre que ce symbole s'éteigne avant d'introduire l'aliment.

Cuisson avec l'assistant personnel de cuisson (APC)

RECETTES AUTOMATIQUES DU FOUR

VOLAILLES		 POULET	
		 CANARD	
		 OIE	
		 DINDE	
		 CUISSES	
VIANDES		 COCHON DE LAIT	
		 BŒUF	
		 AGNEAU	
		 CÔTES	
POISSONS		 COLIN	
		 SAUMON	
PAINS		 PAIN BLANC	
		 PAIN NOIR	
		 PAIN COMPLET	
PIZZAS		 PIZZA À PÂTE ÉPAISSE	
		 PIZZA À PÂTE FINE	
DESSERTS		 GÂTEAU EN MOULE	
		 GÂTEAU AUX FRUITS	
		 PETIT GÂTEAU AUX FRUITS	
		 GÂTEAU SUR PLAQUE	

 Recettes nécessitant le préchauffage du four à vide.

 Recettes pour lesquelles il faut retourner l'aliment.

POUR CUISINER AVEC L'ASSISTANT PERSONNEL DE CUISSON

Allumez le four en appuyant sur la touche .

Appuyez sur la touche .



Sélection de la recette.

Tournez la commande de gauche jusqu'à ce que le type d'aliment que vous souhaitez cuisiner apparaisse en plus grand.

Dans la partie droite de l'écran, vous trouverez ensuite les recettes disponibles pour le type d'aliment sélectionné. Sélectionnez avec la commande de droite la recette souhaitée et validez la sélection avec la touche .

Dans la partie droite de l'écran, vous trouvez ensuite l'information dont le four a besoin pour programmer la cuisson.

Selon la recette sélectionnée, le four vous demande d'introduire :

POIDS DE L'ALIMENT : Sélectionnez avec la commande de droite et validez avec la touche .

TEMPÉRATURE : Validez la température proposée pour la recette ou sélectionnez-en une autre avec la commande de droite et validez avec la touche .

DEGRÉ DE FINITION : Vous pouvez sélectionner le degré de finition pour certaines cuissons :

- **ÉLEVÉ :** Bien cuit
- **MOYEN :** À point
- **FAIBLE :** Saignant

Une fois tous les paramètres sélectionnés, validez avec la touche .

Le four commence la cuisson et l'écran de sélection fait place à l'écran de cuisson sur lequel vous trouvez l'information suivante :

- La température de cuisson sélectionnée
- Le temps de cuisson restant
- La recette sélectionnée

Une fois la cuisson terminée, une alarme sonne pendant environ 90 secondes et le symbole de cuisson clignote sur l'écran. Appuyez sur n'importe quelle touche pour arrêter l'alarme.

Le four s'éteint automatiquement.



INFORMATION

Pendant les 10 premières minutes de cuisson, vous pouvez modifier le poids et le degré de finition ou programmer une heure de fin de cuisson.

Une fois ce temps écoulé, ces valeurs se fixent et ne pourront pas être modifiées.

Pour modifier ces valeurs de cuisson, appuyez sur la touche  et le four retourne sur l'écran de sélection.

Suivez les étapes indiquées précédemment.

À tout moment de la cuisson, vous pouvez :

Modifier la température de cuisson, en appuyant sur la touche . Validez avec la touche .

Programmer une alarme. En appuyant sur la touche .

Modifier la programmation d'une alarme programmée. En appuyant sur la touche .

Pour programmer ou modifier une programmation, suivez les instructions du paragraphe « Programmation de cuisson avec minuterie » que vous trouverez plus loin dans ce guide d'utilisation.

PRÉCHAUFFAGE À VIDE

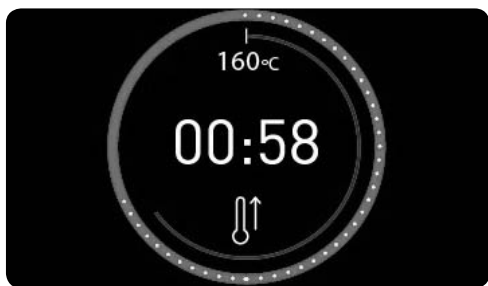



Les recettes présentes dans le tableau avec le symbole  requièrent l'introduction de l'aliment dans un four déjà chaud.

Lorsque vous sélectionnez une de ces recettes, le symbole  s'affiche à l'écran lorsque la cuisson commence. Lorsque le four atteint la température de cuisson, le symbole clignote et une alarme sonne pour vous avertir que vous pouvez introduire l'aliment.

L'alarme s'éteint automatiquement lorsque vous ouvrez la porte du four pour introduire l'aliment et le temps restant s'affiche sur l'écran de cuisson.

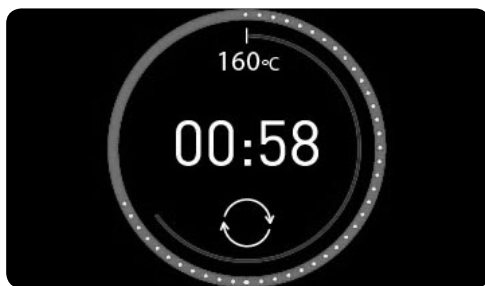
RETOURNER L'ALIMENT



Pour les recettes présentes dans le tableau avec le symbole , il faut retourner l'aliment pendant la cuisson.

Le four vous indique quand vous devez le faire avec une alarme sonore et le symbole  s'affiche sur l'écran de cuisson.

L'alarme s'éteint automatiquement lorsque vous ouvrez la porte du four pour retourner l'aliment.

Programmation avec minuterie du four

OPTIONS DE MINUTERIE

Pour programmer une cuisson, vous disposez des options de minuterie suivantes :

 **Avertisseur** : Une alarme sonne lorsque le temps de programmation est écoulé. La cuisson NE S'ARRÊTE PAS lorsque le temps est écoulé. Vous pouvez également programmer une alarme lorsque le four n'est pas en pleine cuisson.



INFORMATION

Vous pouvez programmer une alarme à tout moment, que le four soit en pleine cuisson ou non.

Les autres options de minuterie sont disponibles uniquement lorsque le four est en pleine cuisson.

 **Durée de cuisson** : Permet de sélectionner le temps pendant lequel le four sera en pleine cuisson.

Lorsque le temps programmé est écoulé, une alarme sonne, le symbole  clignote et le four cesse automatiquement de chauffer.

Appuyez sur n'importe quelle touche pour arrêter l'alarme et éteindre le four.

 **Heure de fin de cuisson** : Permet de sélectionner l'heure jusqu'à laquelle le four sera en pleine cuisson.

Lorsque l'heure programmée arrive, une alarme sonne, le symbole  clignote et le four cesse automatiquement de chauffer.

Appuyez sur n'importe quelle touche pour arrêter l'alarme et éteindre le four.

Début de cuisson différé ( **Durée** +  **Heure de fin de cuisson**) : Permet de pro-

grammer le four pour qu'il commence la cuisson automatiquement et s'éteigne également automatiquement une fois le temps de cuisson programmé écoulé.



INFORMATION

Pour programmer cette option, vous devrez programmer consécutivement la durée et l'heure de fin de cuisson.

Vous pouvez accéder aux options de programmation à tout moment d'une cuisson.

De même, vous pouvez accéder à la modification d'une programmation déjà établie.



INFORMATION

Si vous avez sélectionné une recette automatique, le four détermine automatiquement la durée de cuisson, c'est pourquoi cette option n'est pas disponible.

Dans ce cas, vous pouvez :

Programmer l'heure de fin de cuisson pendant les dix premières minutes de cuisson.

Programmer une alarme à tout moment.

POUR PROGRAMMER LES OPTIONS DE MINUTERIE

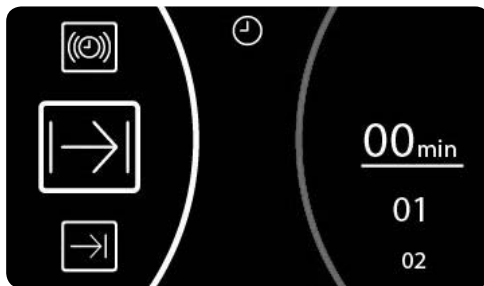

Programmation durée de cuisson.

1. Appuyez sur la touche pour accéder au menu d'options de minuterie.
2. Tournez la commande de gauche pour sélectionner l'option de programmation souhaitée.
3. Tournez la commande de droite pour sélectionner la durée ou l'heure de fin selon l'option choisie.



INFORMATION

Le four n'autorise pas la sélection d'une heure de fin antérieure à l'heure actuelle.

Lorsqu'une heure de fin est programmée, l'heure actuelle est indiquée sur la partie centrale pour faciliter la sélection.

4. Validez la sélection avec la touche .
5. Ensuite, l'écran de cuisson réapparaît. Vous pourrez voir les minuteries programmées à droite du cercle central.

Fonctions de sécurité

VERROUILLAGE DE SÉCURITÉ POUR LES ENFANTS (VERROUILLAGE DU PANNEAU DE CONTRÔLE)



Cette fonction peut être sélectionnée à tout moment pendant l'utilisation du four.

- **Avec le four éteint.** Le verrouillage pour les enfants empêche le four de s'allumer en appuyant sur la touche .

- **Pendant l'utilisation du four.** Si la fonction s'active alors que le four est en pleine cuisson ou en veille, la réponse du clavier se verrouille et les commandes ainsi que les valeurs de cuisson ne pourront pas être modifiées.

Pour activer la fonction, appuyez de façon prolongée sur la touche jusqu'à ce qu'un bip sonore retentisse et que le symbole s'affiche.

s'affiche à l'écran. Le panneau de contrôle est verrouillé.

Pour désactiver la fonction, appuyez de nouveau de façon prolongée sur la touche  jusqu'à ce qu'un bip sonore retentisse et que le symbole  disparaisse.

VERROUILLAGE MANUEL DE PORTE

Disponible pour les modèles à pyrolyse uniquement.

Sur les modèles à pyrolyse, le verrouillage de sécurité pour les enfants comprend le verrouillage de la porte, ce qui empêche son ouverture.

Pour ouvrir la porte, vous devez désactiver le verrouillage de sécurité pour les enfants en suivant les instructions indiquées précédemment.



MISE EN GARDE

Avant d'activer le verrouillage, assurez-vous que la porte du four est bien fermée. Si la porte n'est pas bien fermée, elle ne se verrouille pas, une alarme sonne et le symbole  clignote sur l'écran.

Si cela se produit, fermez correctement la porte pour que l'alarme disparaisse et qu'elle puisse se verrouiller.

Si vous ne souhaitez pas verrouiller la porte, désactivez la sécurité pour enfants.

Fonction Teka Hydroclean®

Cette fonction facilite le nettoyage des traces de graisse et de saleté pouvant rester collées aux parois du four.

Pour un nettoyage plus efficace, évitez que la saleté ne s'accumule. Nettoyez régulièrement le four.

PROGRAMMER LA FONCTION TEKA HYDROCLEAN®



MISE EN GARDE

Ne versez pas d'eau à l'intérieur du four chaud : cette opération peut endommager l'émail de votre four.

Effectuez systématiquement le cycle de nettoyage lorsque le four est froid. Si le cycle est lancé avec un four trop chaud, il est possible que le résultat ne soit pas celui attendu en plus d'endommager l'émail

Retirez préalablement les plaques et tous les accessoires présents à l'intérieur du four, y compris les supports de plaques ou les rails télescopiques.

Pour ce faire, suivez les instructions figurant dans le manuel d'installation et d'entretien fourni avec votre four.

1. Lorsque le four est froid, placez un chiffon au fond de celui-ci.

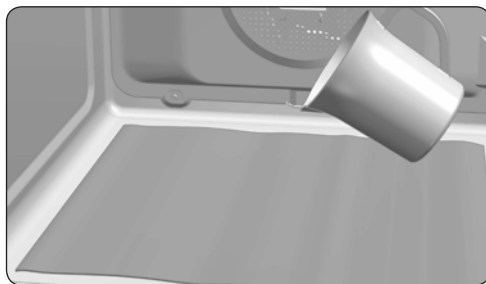



2. Versez lentement 200 ml d'eau dans la cavité inférieure du four.



INFORMATION

Pour un meilleur résultat, ajoutez une cuillère de liquide vaisselle doux dans le verre d'eau avant de le verser sur le chiffon.

3. Allumez le four, tournez la commande de gauche pour sélectionner la fonction  et validez avec .

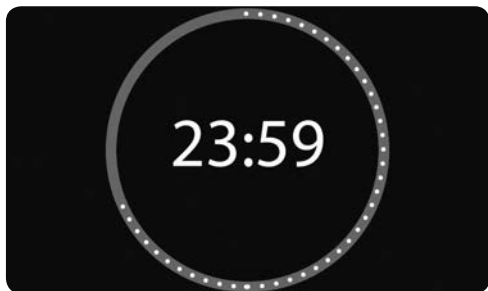

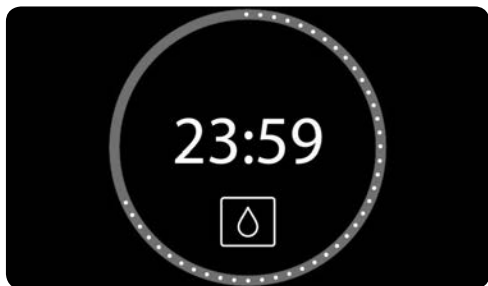

4. Un signal sonore est alors émis pour confirmer la mise en marche de la fonction Teka Hydroclean®.

Sur l'écran, vous voyez le symbole  et le temps restant pour que la fonction s'achève.



IMPORTANT

La durée de cette fonction ne peut pas être modifiée. Pour terminer avant l'écoulement total de cette durée, éteignez le four en appuyant sur la touche .

5. À l'heure de fin de cycle, le four s'éteint, un signal sonore retentit et le symbole  se met à clignoter rapidement.



IMPORTANT

Maintenez la porte du four fermée jusqu'à la fin de la fonction Hydroclean®.

La phase de refroidissement est nécessaire au bon déroulement de cette dernière.

6. Appuyez sur n'importe quelle touche pour couper le signal sonore et éteindre le symbole .
7. Le four s'éteint automatiquement.
8. Le four est prêt pour retirer les restes de saleté et l'excès d'eau avec le chiffon.

La fonction Hydroclean® est réalisée à basse température. Les durées de refroidissement peuvent néanmoins varier en fonction de la température ambiante.



MISE EN GARDE

Avant de toucher directement la surface intérieure du four, veillez à ce que la température soit appropriée.

Si un nettoyage en profondeur s'avère nécessaire après l'utilisation de la fonction Hydroclean®, utilisez des détergents neutres et des éponges douces non abrasives.

Fonction d'auto-nettoyage par pyrolyse



MISE EN GARDE

Avant d'effectuer le cycle de nettoyage par pyrolyse, lisez attentivement les instructions de sécurité que vous trouverez au début du manuel d'installation et d'entretien.

Cette fonction vous permet de réaliser un cycle de nettoyage par pyrolyse durant lequel, en raison des hautes températures atteintes à l'intérieur du four, se produit un processus de carbonisation des graisses accumulées.

Il est généralement recommandé de réaliser une pyrolyse toutes les 4-5 cuissons et d'utiliser le programme le plus approprié au niveau de saleté du four. Plus le four est sale, plus la durée du programme doit être longue.

L'éclairage intérieur du four restera éteint durant la pyrolyse

PROGRAMMER LA FONCTION PYROLYSE



IMPORTANT

Avant de lancer la pyrolyse, il est indispensable de retirer tous les accessoires et la vaisselle du four, y compris les supports des plaques et/ou les rails télescopiques. Pour ce faire, suivez les instructions figurant dans le manuel d'installation et d'entretien fourni avec votre four.



MISE EN GARDE

Retirer du four tout écoulement ou résidu de saleté majeur car ils pourraient prendre feu et déclencher un incendie durant la pyrolyse.



MISE EN GARDE

Avant de mettre en marche la pyrolyse, assurez-vous que la porte du four est bien fermée.

1. Allumez le four et sélectionnez la fonction Pyrolyse  en tournant la commande de gauche.

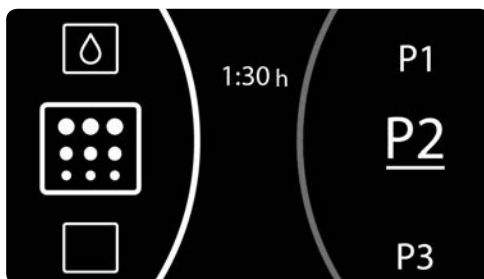

2. Avec la commande de droite, sélectionnez le programme de pyrolyse le plus adapté au niveau de saleté de votre four :
P1 : Pyrolyse douce. Durée 1 heure.
P2 : Pyrolyse normale. Durée 1 heure et 30 minutes.
P3 : Pyrolyse forte. Durée 2 heures.
3. Validez la sélection avec la touche . Le verrouillage automatique de porte s'effectue immédiatement après.



MISE EN GARDE



Si la porte n'est pas bien fermée, la pyrolyse ne commence pas. Une alarme sonne et le symbole  clignote sur l'écran.

Si cela se produit, fermez correctement la porte pour qu'elle se verrouille et que la pyrolyse puisse commencer.

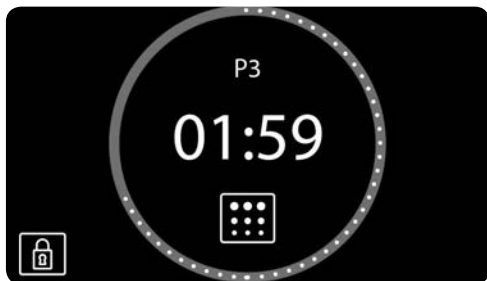
4. Lorsque la porte est verrouillée, le symbole  s'allume sur l'écran de l'horloge et le temps restant avant la fin de la pyrolyse est indiqué.

**IMPORTANT**

Le four est programmé et effectue le cycle de nettoyage par pyrolyse.

Pendant les 10 premières minutes, vous pouvez retarder le début de la pyrolyse en programmant son heure de fin. Pour cela, appuyez sur la touche  pour accéder au menu d'options de minuterie. Une fois l'heure de fin sélectionnée, validez avec la touche .

Pendant la pyrolyse, vous ne pouvez sélectionner aucune autre option de minuterie. Mais vous pouvez, si vous le souhaitez, activer le verrouillage de sécurité pour les enfants.

N'essayez pas non plus d'ouvrir la porte du four au risque d'interrompre le processus de nettoyage.

5. Lorsque le cycle de nettoyage par pyrolyse s'achève, un signal sonore est émis, le symbole  clignote et l'indication 00:00 s'affiche à l'écran.

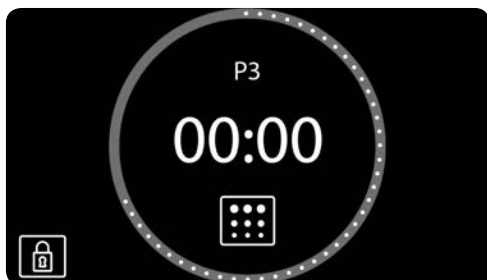

6. Appuyez sur n'importe quel symbole de l'horloge pour arrêter le signal sonore.
7. Le four s'éteint automatiquement.
8. Le processus de chauffage du four est terminé, le four reste cependant très chaud et ne peut être utilisé.

Le refroidissement se poursuit jusqu'à ce que le four ait refroidi et le symbole  reste allumé.

**IMPORTANT**

En raison des fortes températures à l'intérieur du four, le temps de refroidissement peut varier en fonction de la température ambiante.

9. Une fois que votre four a refroidi, le symbole  s'éteint et la porte est déverrouillée.
10. Ouvrez la porte du four et passez un chiffon humide à l'intérieur de la cavité, afin de retirer la cendre produite durant le cycle de nettoyage. Dans les coins difficiles d'accès à l'intérieur du four, il faudra utiliser une éponge en fibre non métallique.
11. Une fois l'intérieur du four propre, n'oubliez pas de remettre les supports et les ustensiles.
12. Le four est prêt pour une prochaine utilisation.

**IMPORTANT**

Si vous repérez un quelconque problème dans la programmation et l'utilisation de cette fonction, reportez-vous au guide d'utilisation et d'entretien fourni avec votre four.

ANNULATION DE LA PYROLYSE

La pyrolyse est une fonction automatique, elle se met donc uniquement en marche par le biais de la programmation de l'horloge. Pour annuler une pyrolyse en cours, il est nécessaire de déprogrammer le four en suivant les instructions suivantes :

1. Appuyez sur la touche ①.

La pyrolyse s'arrête.

2. En fonction de la température intérieure du four, ces deux situations peuvent se produire :

- a) Température à l'intérieur dangereuse : Dans ce cas, la porte restera verrouillée jusqu'à ce que la température atteigne des valeurs sûres. Le symbole  s'affichera à l'écran.

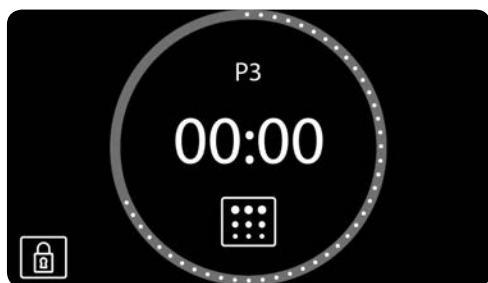

Une fois que la porte est déverrouillée et peut s'ouvrir, le symbole  disparaît et l'heure s'affiche de nouveau sur l'écran de l'horloge.

- b) Température à l'intérieur sûre : Si la température à l'intérieur du four est sûre, le déverrouillage s'effectue immédiatement.
3. Température à l'intérieur sûre : Si la température à l'intérieur du four est sûre, le déverrouillage s'effectue immédiatement et le four retourne sur l'écran de veille.

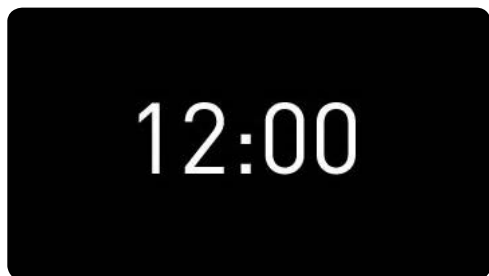

Backofenbeschreibung

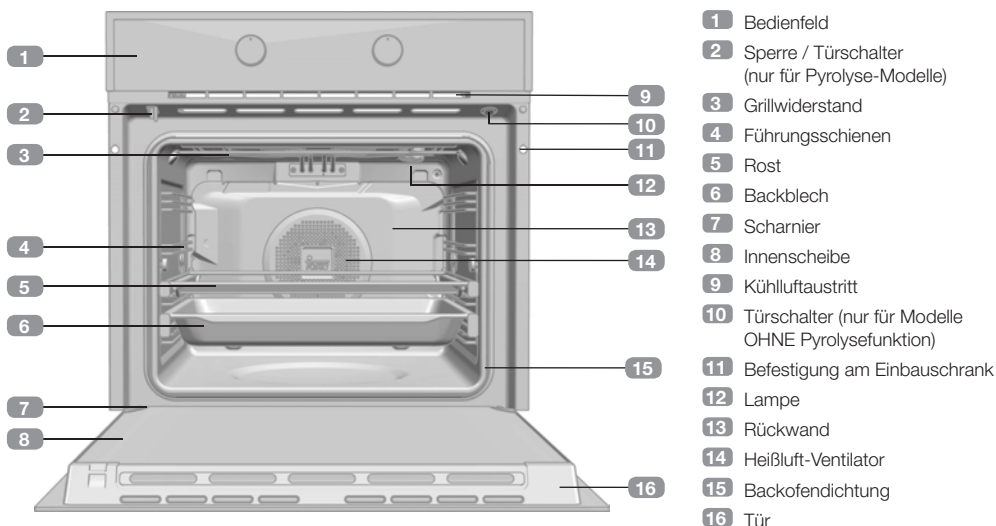

Bedienfeld

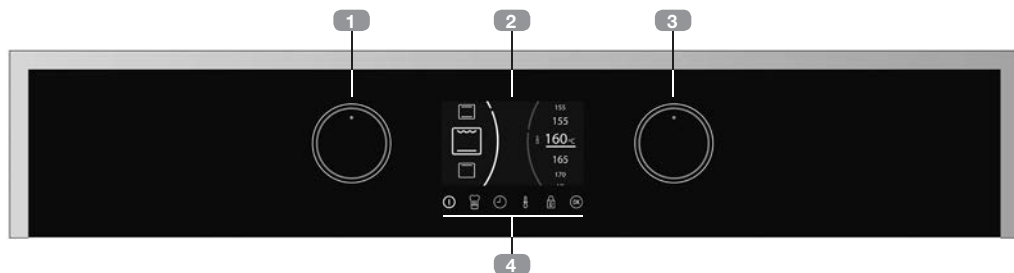

- 1 Schalter zur Navigation in den Menüs auf der linken Seite. Wahlschalter Garfunktionen
 2 Anzeigebild
 3 Schalter zur Navigation in den Menüs auf der rechten Seite. Wahlschalter zur Einstellung der Garfunktionen
 4 Tasten

-  **Backofen Ein/Ausschalten**
-  **Zugang zum persönlichen Garassistenten (PGA)**
-  **Zugang zu den Funktionen zur Zeiteinstellung und Programmierung des Backofens**
-  **Änderung der Backofentemperatur**
-  **Ein/Ausschalten der Tastatur/Türsperre je nach Modell**
-  **Bestätigungstaste, Aus/Einschalten Innenbeleuchtung**

Einschalten und Uhreinstellung

Wird der Backofen zum ersten Mal an das Stromnetz angeschlossen, erscheint das Logo und anschließend blinkt die Anzeige 12:00.

Um den Backofen benutzen zu können, muss die Uhrzeit eingestellt werden.

Dazu müssen Sie die Stunden mit dem linken Schalter und die Minuten mit dem rechten Schalter wählen.

Bestätigen Sie die Auswahl mit der Taste  oder warten Sie ein paar Sekunden ab.

Es ertönt ein akustisches Signal zur Bestätigung und die Uhrzeit blinkt nicht mehr.

Änderung der Uhrzeit:

Bei ausgeschaltetem Backofen (Startbild) die Taste  gedrückt halten, bis die Uhrzeit zu blinken beginnt. Befolgen Sie dann die Schritte zur Änderung der Uhrzeit.



ACHTUNG

Die Empfindlichkeit der Touch-Tasten passt sich ständig an die Umgebungsbedingungen an. Beim Anschluss des Ofens an das Stromnetz ist darauf zu achten, dass die Oberfläche des Bedienfelds sauber und frei von Hindernissen ist.



Reagiert die Anzeige bei der Berührung des Glases nicht richtig, muss der Backofen vom Stromnetz getrennt und nach einem Augenblick wieder angeschlossen werden. Auf diese Weise stellen sich die Sensoren automatisch richtig ein und reagieren wieder auf Berührung mit dem Finger.

DEMO-MODUS (Sonderfunktion für Ausstellungen)

Bei eingeschaltetem DEMO-Modus kann der Backofen ohne Aufheizen bedient werden.

Es wird empfohlen, diesen Modus einzuschalten, wenn der Backofen mit Netzanschluss auf einer Ausstellung installiert wird.

Einschalten des DEMO-Modus

Bevor die Uhrzeit eingestellt wird, gleichzeitig die Tasten  und  drücken, bis auf dem Bildschirm die Anzeige «DEMO Mode ON» erscheint.

Anschließend die Uhrzeit einstellen.

Die Bezeichnung «DEMO» erscheint ständig auf dem Bildschirm und der Backofen kann normal bedient werden, heizt aber nicht.

Zum Ausschalten des DEMO-Modus muss die Stromversorgung des Backofens abgeschaltet werden.



ACHTUNG

Bei einem Stromausfall wird die gesamte Programmierung der elektronischen Uhr gelöscht.

Als Anzeige erscheint dann 12:00.

Sie können die Uhrzeit entsprechend den obigen Anweisungen einstellen.

Wenn die Backofentür vor dem Stromausfall gesperrt war, leuchtet das Sperrsymbol auf, bis die Tür entsperrt wird.

Dies kann in Abhängigkeit von der Temperatur des Backofens mehrere Minuten dauern. Während dieser Zeit können Sie die Uhr nicht einstellen.

Sobald die Tür entsperrt ist, können Sie die Uhrzeit einstellen, indem Sie die o. a. Anweisungen befolgen.



Beschreibung des Bedienfelds

Im Anschluss sind die Informationen beschrieben, die auf dem Display Ihres Backofens angezeigt werden.

STARTANZEIGE

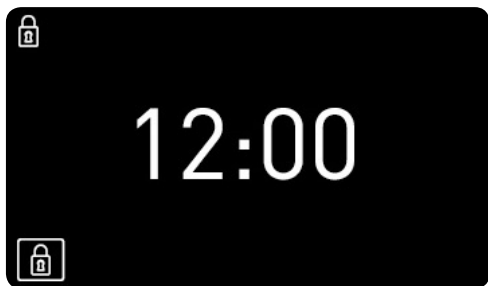
Diese Anzeige erscheint, wenn der Backofen nicht in Betrieb, aber an die Stromversorgung angeschlossen ist.



Wenn die Tastatur- oder Türsperre eingeschaltet ist, erscheinen die Symbole  und  auf der linken Seite.

Wurde ein Alarm programmiert, wird nicht die Uhrzeit angezeigt, sondern der Countdown (siehe die folgende Abbildung).

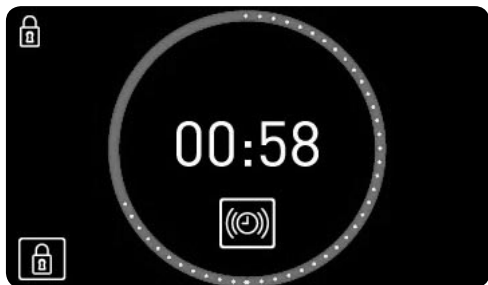

AUSWAHLBILD



Funktionsauswahl

Während der Auswahl einer Garfunktion, eines automatischen Rezepts oder einer Uhrfunktion ist die Anzeige in zwei Bereiche aufgeteilt:

LINKER BEREICH: In diesem Bereich werden die für die Auswahl verfügbaren Garfunktionen, die automatischen Rezepte oder die Programmierfunktionen der Uhr dargestellt.

Um eine Funktion auszuwählen, den linken Schalter drehen, bis die gewünschte Funktion vergrößert erscheint, und die Auswahl mit der Taste  bestätigen (wenn keine Taste berührt wird, bestätigt der Backofen die Auswahl nach ein paar Sekunden automatisch).

RECHTER BEREICH: In diesem Bereich werden die Werte angezeigt, die entsprechend der gewählten Funktion ausgewählt werden können: Temperatur, Gewicht, Dauer, Ende der Garzeit...

Um einen Wert auszuwählen, den rechten Schalter drehen, bis der gewünschte Wert vergrößert erscheint, und die Auswahl mit der Taste  bestätigen (wenn keine Taste berührt wird, bestätigt der Backofen die Auswahl nach ein paar Sekunden automatisch).

GARANZEIGE

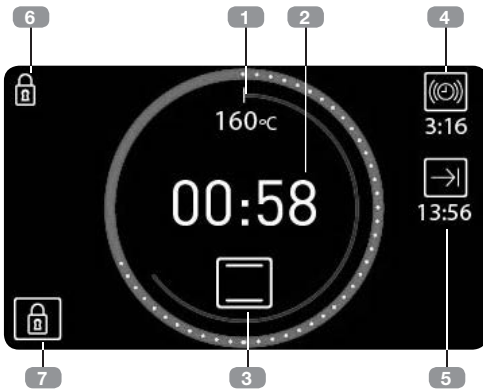

Während des Garens erscheinen die Informationen zum Backofenstatus auf der Anzeige um zwei zentrale Kreise herum:

Innenkreis: Temperatur (rot) Dieser Kreis zeigt die gewählte Temperatur skaliert an.

Außenkreis: Zeit

- Rot, wenn die Zeit angezeigt wird, die der Backofen bereits gart. Alle 2 Minuten erscheint ein weißer Punkt.
- Blau, wenn die Zeit angezeigt wird, die bis zur Beendigung des Garvorgangs aussteht (Countdown). Alle 2 Minuten verschwindet ein weißer Punkt.

Innerhalb dieser Kreise werden folgende Angaben über den Garvorgang angezeigt:

- 1. Gewählte Temperatur:** Das °C-Symbol blinkt, bis die gewählte Temperatur erreicht ist, und immer dann, wenn der Backofen das Gargut erhitzt.

2. Gardauer:

- Wenn die Uhr nicht programmiert wurde, wird die Dauer angezeigt, die der Backofen schon gart, und der Zeitkreis erscheint rot.
- Wurde eine Programmierung vorgenommen, wird die Zeit angezeigt, die bis zum Ende der Garzeit aussteht (Countdown), und der Zeitkreis erscheint blau.
- Wenn der Backofen programmiert ist, sich aber noch in der Wartezeit befindet (der Garvorgang hat noch nicht begonnen), wird die Gesamtdauer der programmierten Garzeit angezeigt.

3. Gewählte Garfunktion oder automatisches Rezept:

Außerhalb dieser Kreise werden folgende Angaben zu den Zusatzfunktionen angezeigt:

RECHTER BEREICH: Wenn Zeitfunktionen programmiert wurden, erscheinen die Angaben zu diesen Funktionen auf der rechten Seite.

- 4. Timer:** Countdown bis zum Ablauf des programmierten Alarms.

- 5. Garzeit-Ende**

LINKER BEREICH: Auskunft über die eingeschalteten Sicherheitsfunktionen.

- 6. Tastatursperre:** Leuchtet, wenn die Kindersicherung eingeschaltet ist.
- 7. Türsperre (NUR FÜR PYROLYSE-MODELLE):** Leuchtet, wenn die manuelle Türsperre eingeschaltet ist.

Nutzung der herkömmlichen Garfunktionen

BACKOFENFUNKTIONEN



HINWEIS

Für eine Beschreibung der einzelnen Funktionen lesen Sie bitte die im Lieferumfang Ihres Backofens enthaltene Übersicht über die Garfunktionen.

- | | | |
|--|-----------------------------|----------------------------------|
| | AUSSCHALTEN | |
| | NORMAL | |
| | NORMAL MIT UMLUFT | |
| | GRILL UND UNTERHITZE | |
| | MAXIGRILL | |
| | | |
| | | GRILL |
| | | |
| | | UNTERHITZE |
| | | |
| | | PIZZA |
| | | |
| | | TURBO |
| | ECO | ECO |
| | | NIEDERTEMPERATUR-GAREN |
| | | TEIGE AUFGEHEN LASSEN |
| | | AUFTAUEN |
| | | HYDROCLEAN |
| | | PYROLYSE (je nach Modell) |

Funktionen mit automatischer Schnellvorheizung

NUTZUNG DER HERKÖMMLICHEN GAR FUNKTIONEN



Funktionsauswahl

Schalten Sie den Backofen ein, indem Sie die Taste  berühren.

Drehen Sie den linken Schalter, bis die gewünschte Funktion vergrößert erscheint.

Anschließend erscheint rechts die für die gewählte Funktion empfohlene Temperatur.



Wenn gewünscht, können Sie diese Temperatur ändern, indem Sie den rechten Schalter drehen.

Bestätigen Sie die Auswahl mit der Taste .

Der Backofen startet den Garvorgang.

Während des Garvorgangs können Sie zu jedem beliebigen Zeitpunkt:

- **die Garfunktion ändern**, indem der linke Schalter gedreht wird.

- **die Gartemperatur ändern**, indem der rechte Schalter gedreht wird.
- **einen Alarm oder die Dauer/Endzeit des Garvorgangs programmieren** (durch Berühren der Taste .
- **die Programmierung eines Alarms oder der Dauer/Endzeit ändern** (durch Berühren der Taste .



HINWEIS

Zur Programmierung oder Änderung einer Programmierung lesen Sie bitte den Abschnitt «Zeiteinstellung des Garvorgangs» weiter unten in dieser Bedienungsanleitung.

AUTOMATISCHE SCHNELLVORHEIZUNG

































Die angegebenen Funktionen beinhalten eine automatische Schnellvorheizung.

Während der Schnellvorheizung leuchtet das Symbol .

Es wird empfohlen, das Gargut erst dann in den Backofen zu stellen, wenn dieses Symbol nicht mehr aufleuchtet.

Kochen mit dem persönlichen Garassistenten (PGA)

AUTOMATISCHE BACKOFEN-REZEPTE

GEFLÜGEL		 HÄHNCHEN	
		 ENTE	
		 GANS	
		 PUTE	
		 SCHENKEL	
FLEISCH		 SPANFERKEL	
		 OCHSE	
		 LAMM	
		 KOTELETTS	
FISCH		 SEEHECHT	
		 LACHS	
BROT		 WEISSBROT	
		 DUNKLES BROT	
		 VOLLKORNBROT	
PIZZA		 DICKE PIZZA	
		 DÜNNE PIZZA	
NACHSPEISEN		 FORMKUCHEN	
		 GROSSER OBSTKUCHEN	
		 KLEINER OBSTKUCHEN	
		 BLECHKUCHEN	

 Rezepte, bei denen der leere Backofen vorgeheizt werden muss.

 Rezepte, bei denen das Gargut gewendet werden muss.

NUTZUNG DES PERSÖNLICHEN GARASSISTENTEN

Schalten Sie den Backofen ein, indem Sie die Taste  berühren.



Rezeptauswahl

Berühren Sie die Taste .

Drehen Sie den linken Schalter, bis die Speise, die Sie zubereiten möchten, vergrößert erscheint.

Im rechten Bereich werden anschließend die für die gewählte Speiseart verfügbaren Rezepte angezeigt. Wählen Sie das gewünschte Rezept mit dem rechten Schalter und bestätigen Sie die Auswahl mit der Taste .

Im rechten Bereich erscheinen im Anschluss die Angaben, die der Backofen zum Programmieren des Garvorgangs benötigt.

Je nach gewähltem Rezept fordert der Backofen zur Eingabe folgender Angaben auf:

GEWICHT DES GARGUTS: Wählen Sie das Gewicht mit dem rechten Schalter und bestätigen Sie es mit der Taste .

TEMPERATUR: Bestätigen Sie die vorgeschlagene Temperatur oder wählen Sie mit dem rechten Schalter eine andere. Bestätigen Sie sie mit der Taste .

GARSTUFE: Bei einigen Zubereitungen können Sie die Garstufe wählen:

- **HIGH:** Well done
- **MEDIUM:** Medium
- **LOW:** Rare

Nachdem alle Parameter ausgewählt wurden, müssen Sie sie mit der Taste  bestätigen.

Der Backofen startet den Garvorgang und die Auswahlanzeige wechselt zur Garanzeige, auf der folgende Informationen zu sehen sind:

- Gewählte Gartemperatur
- Restliche Garzeit
- Gewähltes Rezept

Nach Beendigung des Garvorgangs ertönt ca. 90 Sekunden lang ein akustisches Signal und auf der Anzeige blinkt das Garsymbol. Berühren Sie eine beliebige Taste, um den Ton auszuschalten.

Der Backofen schaltet sich automatisch ab.



HINWEIS



In den ersten 10 Minuten der Garzeit können Sie Gewicht und Garstufe ändern oder die Endzeit des Garvorgangs programmieren.

Nach dieser Zeit können diese Werte nicht mehr geändert werden.

Um diese Garparameter zu ändern, müssen Sie die Taste  berühren, um zur Auswahlanzeige zurückzukehren.

Befolgen Sie dann die o. a. Schritte.

Während des Garvorgangs können Sie zu jedem beliebigen Zeitpunkt:

die Gartemperatur ändern, indem sie die Taste  berühren und mit der Taste  bestätigen.

einen Alarm programmieren (durch Berühren der Taste .

die Programmierung eines Alarms ändern (durch Berühren der Taste .

Zur Programmierung oder Änderung einer Programmierung befolgen Sie bitte die Anweisungen im Abschnitt «Zeiteinstellung des Garvorgangs» weiter unten in dieser Bedienungsanleitung.

LEEREN BACKOFEN VORHEIZEN

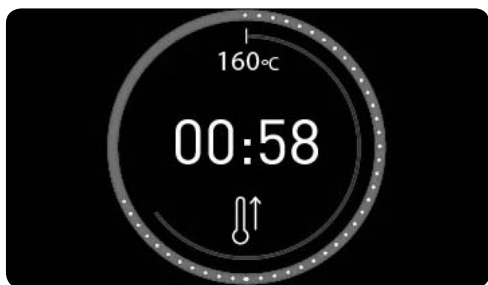



Bei den in der Tabelle mit dem Symbol  gekennzeichneten Rezepten muss das Gargut in den zuvor vorgeheizten Backofen gestellt werden.

Wird eines dieser Rezepte gewählt, erscheint bei Garbeginn das Symbol  auf der Anzeige. Sobald der Backofen die Gartemperatur erreicht hat, blinkt das Symbol und es ertönt ein akustisches Signal, das angibt, dass das Gargut nun hineingestellt werden kann.

Das akustische Signal verstummt beim Öffnen der Backofentür zum Einführen des Garguts automatisch. Auf der Garanzeige wird die verbleibende Zeit angegeben.

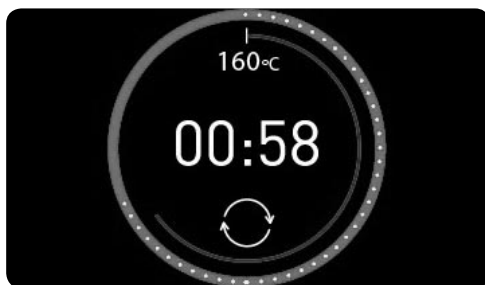
GARGUT WENDEN



Bei den in der Tabelle mit dem Symbol  gekennzeichneten Rezepten muss das Gargut während des Garvorgangs gewendet werden.

Der Backofen weist Sie auf diesen Zeitpunkt mit einem akustischen Signal hin, und auf der Garanzeige erscheint das Symbol .

Das akustische Signal verstummt automatisch, wenn die Backofentür zum Wenden des Garguts geöffnet wird.

Zeiteinstellung des Backofens

OPTIONEN DER ZEITEINSTELLUNG

Folgende Optionen stehen zur Zeiteinstellung beim Programmieren eines Garvorgangs zur Verfügung:

 **Timer:** Programmiert einen Alarm, der nach Ablauf der eingestellten Zeit ertönt. Der Garvorgang wird nach Ablauf der Zeit NICHT unterbrochen. Sie können auch einen Alarm einstellen, wenn der Backofen nicht in Betrieb ist.



HINWEIS

Sie können jederzeit, d. h. unabhängig davon, ob der Backofen in Betrieb ist oder nicht, einen Alarm programmieren.

Die restlichen Optionen der Zeiteinstellung sind nur verfügbar, wenn der Backofen in Betrieb ist.

 **Gardauer:** Damit kann die gewünschte Gardauer gewählt werden.



Nach Ablauf der programmierten Dauer ertönt ein akustisches Signal, das Symbol  blinkt und der Backofen hört automatisch auf zu heizen.

Berühren Sie eine beliebige Taste, um den Alarmton und den Backofen auszuschalten.

 **Garzeit-Ende:** Damit kann die Uhrzeit gewählt werden, bis zu der der Backofen garen soll.

Sobald die programmierte Uhrzeit erreicht ist, ertönt ein akustisches Signal, das Symbol  blinkt und der Backofen hört automatisch auf zu heizen.

Berühren Sie eine beliebige Taste, um den Alarmton und den Backofen auszuschalten.

Verzögerter Garbeginn ( **Gardauer** +  **Garzeit-Ende**): Damit kann der Backofen so programmiert werden, dass er den Garvorgang

automatisch beginnt und sich automatisch abschaltet, sobald die programmierte Gardauer abgelaufen ist.



HINWEIS

Zur Programmierung dieser Option müssen Gardauer und Garzeit-Ende nacheinander programmiert werden.

Sie haben während des Garvorgangs jederzeit Zugriff auf die Programmieroptionen.

Auf die gleiche Weise können Sie auch eine bereits festgelegte Programmierung ändern.



HINWEIS

Wenn Sie ein automatisches Rezept gewählt haben, bestimmt der Backofen die Gardauer automatisch. Aus diesem Grund ist diese Option nicht verfügbar.

In diesem Fall können Sie jedoch:

Die Endzeit in den ersten zehn Minuten des Garvorgangs programmieren.

Jederzeit einen Alarm programmieren.

PROGRAMMIERUNG DER OPTIONEN DER ZEITEINSTELLUNG:

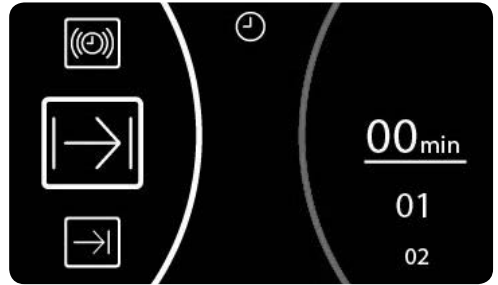

Programmierung der Gardauer

1. Berühren Sie die Taste , um zum Menü der Optionen der Zeiteinstellung zu gelangen.
2. Drehen Sie den linken Schalter, um die gewünschte Programmieroption zu wählen.
3. Drehen Sie den rechten Schalter, um die Gardauer oder das Garzeit-Ende je nach gewählter Option einzustellen.



HINWEIS

Es ist nicht möglich, ein Garzeit-Ende zu wählen, das vor der aktuellen Uhrzeit liegt.

Beim Programmieren des Garzeit-Endes wird als Hilfestellung die aktuelle Uhrzeit in der Mitte angezeigt.

4. Bestätigen Sie die Auswahl mit der Taste .
5. Anschließend erscheint erneut die Garanzeige. Sie können die programmierten Zeiteinstellungen rechts neben dem mittleren Kreis sehen.

Sicherheitsfunktionen

KINDERSICHERUNG (SPERRE DES BEDIENFELDS)



Diese Funktion kann jederzeit eingeschaltet werden:

- **Bei ausgeschaltetem Backofen.** Die Kindersicherung verhindert, dass der Backofen durch Betätigung der Taste  eingeschaltet werden kann.

- **Beim Gebrauch des Backofens.** Wird die Funktion eingeschaltet, während der Backofen in Betrieb oder in Wartestellung ist, wird die Tastatur gesperrt, so dass keine Schalter betätigt und keine Garwerte geändert werden können.

Um die Funktion zu aktivieren, die Taste  so lange berühren, bis 1 Piepton ertönt und das

Symbol  auf der Anzeige erscheint. Das Bedienfeld ist gesperrt.

Um die Funktion auszuschalten, die Taste  erneut so lange berühren, bis 1 Piepton ertönt und das Symbol  auf der Anzeige erscheint.

MANUELLE TÜRSPERRE

Nur bei Pyrolyse-Modellen verfügbar.

Bei den Pyrolyse-Modellen beinhaltet die Kindersicherung die Türsperre, die das Öffnen der Tür verhindert.

Um die Tür öffnen zu können, müssen Sie die Kindersicherung ausschalten, indem Sie die o. a. Anweisungen befolgen.

Teka Hydroclean®-Funktion

Mit dieser Funktion wird die Reinigung der Fett- und Schmutzreste, die an den Backofenwänden haften, erleichtert.

Verhindern Sie die Ansammlung von Schmutz, damit die Reinigung leichter erfolgen kann. Reinigen Sie den Backofen regelmäßig.

PROGRAMMIERUNG DER TEKA HYDROCLEAN®-FUNKTION



ACHTUNG

Gießen Sie kein Wasser in den heißen Backofen. Dadurch könnte die Emaillierung beschädigt werden.

Führen Sie den Reinigungszyklus stets bei kaltem Ofen aus. Wenn Sie ihn bei zu heißem Backofen durchführen, kann das Ergebnis beeinträchtigt und außerdem die Emaillierung beschädigt werden.

Entfernen Sie zuvor die Bleche und alle Zubehörteile inkl. die Führungsschienen bzw. Teleskopauszüge aus dem Backofeninneren.



ACHTUNG

Bevor Sie die Sperre einschalten, müssen Sie sicherstellen, dass die Backofentür richtig geschlossen ist. Wenn die Tür nicht richtig geschlossen ist, wird sie nicht gesperrt. Es ertönt ein akustisches Signal und auf der Anzeige blinkt das Symbol .

In diesem Fall müssen Sie die Tür richtig schließen, damit der Signalton verstummt und die Sperre eingeschaltet wird.

Soll die Tür nicht gesperrt werden, müssen Sie die Kindersicherung ausschalten.

Befolgen Sie dafür die Anweisungen im Einbau- und Wartungshandbuch, das im Lieferumfang des Backofens enthalten ist.

1. Legen Sie bei kaltem Backofen ein Tuch flach auf den Backofenboden.

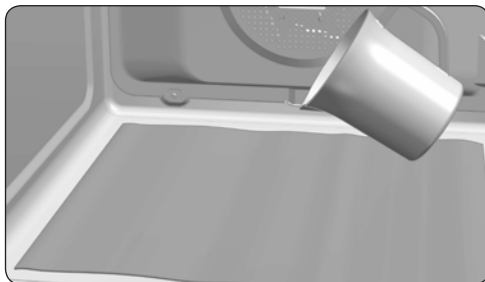



2. Gießen Sie langsam 200 ml Wasser unten in Backofeninnenraum.



HINWEIS

Um das Ergebnis zu verbessern, können Sie dem Glas Wasser einen Teelöffel mildes Geschirrspülmittel hinzufügen, bevor sie es auf das Tuch gießen.

3. Schalten Sie den Backofen ein, drehen Sie den linken Schalter zur Wahl der Funktion  und bestätigen Sie sie mit .

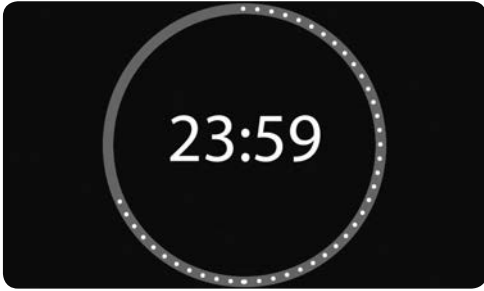

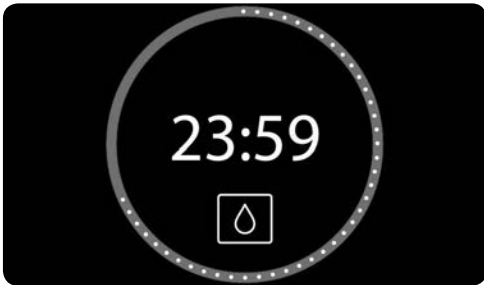

4. Anschließend ertönt ein akustisches Signal zur Bestätigung, dass die Teka Hydroclean®-Funktion eingeschaltet wurde.

Auf dem Bildschirm erscheinen das Symbol  und die restliche Dauer, bis die Funktion beendet ist.



WICHTIG

Die Dauer dieser Funktion kann nicht geändert werden. Um sie vorzeitig zu beenden, müssen Sie den Backofen mit der Taste  ausschalten.

5. Nach Ablauf der programmierten Zeit schaltet sich der Backofen aus, es ertönt ein akustisches Signal und das Symbol  blinkt schnell.



WICHTIG

Öffnen Sie die Ofentür nicht, bis die Hydroclean®-Funktion beendet ist.

Die Abkühlphase ist für den korrekten Ablauf der Funktion notwendig.

6. Berühren Sie mit dem Finger eine beliebige Taste, um das akustische Signal und das Symbol  auszuschalten.
7. Der Backofen schaltet sich automatisch ab.
8. Nun können Sie die Schmutzreste und das übrige Wasser mit dem Tuch entfernen.

Die Hydroclean®-Funktion wird bei niedriger Temperatur durchgeführt. Die Abkühlzeit kann jedoch je nach Außentemperatur unterschiedlich sein.



ACHTUNG

Vergewissern Sie sich, dass die Innenflächen des Ofens ausreichend abgekühlt sind, bevor Sie sie berühren.

Sollte nach der Hydroclean®-Funktion eine gründlichere Reinigung erforderlich sein, verwenden Sie neutrale Reinigungsmittel und nicht scheuernde Schwämme.

Selbstreinigungsfunktion anhand Pyrolyse



ACHTUNG

Bevor Sie den Pyrolyse-Reinigungsvorgang ausführen, müssen Sie die Sicherheitshinweise im Einbau- und Wartungshandbuch aufmerksam lesen.

Mit dieser Funktion erfolgt ein Pyrolyse-Reinigungsvorgang, bei dem das angesammelte Fett durch die heißen Temperaturen, die im Backofeninneren entstehen, verbrannt wird.

Generell wird empfohlen, nach jeweils 4-5 Garvorgängen eine Pyrolyse durchzuführen und dabei das je nach Verschmutzungsgrad des Backofens am besten geeignete Programm zu wählen. Bei stärkerer Verschmutzung müssen Sie ein längeres Programm wählen.

Während der Pyrolyse bleibt das Innenlicht des Backofens ausgeschaltet.

PYROLYSE-FUNKTION PROGRAMMIEREN



WICHTIG

Vor der Durchführung der Pyrolyse entfernen Sie bitte sämtliches Zubehör und Geschirr aus dem Backofen, einschließlich der Führungsschienen der Backbleche und/oder der Teleskopauszüge. Befolgen Sie dafür die Anweisungen im Einbau- und Wartungshandbuch, das im Lieferumfang des Backofens enthalten ist.



ACHTUNG

Entfernen Sie Speisereste oder übermäßigen Schmutz, denn diese könnten sich während der Pyrolyse entzünden und Brandgefahr verursachen.



ACHTUNG

Bevor Sie die Pyrolyse einschalten, müssen Sie sicherstellen, dass die Backofentür richtig geschlossen ist.

1. Schalten Sie den Backofen ein und wählen Sie die Pyrolysefunktion , indem Sie den linken Schalter drehen.

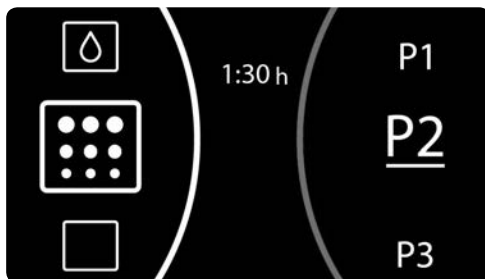

2. Wählen Sie mit dem rechten Schalter das für den Verschmutzungsgrad Ihres Backofens geeignete Pyrolyseprogramm:
 - P1:** Sanfte Pyrolyse. Dauer: 1 Stunde.
 - P2:** Normale Pyrolyse. Dauer: 1,5 Stunden.
 - P3:** Intensive Pyrolyse. Dauer: 2 Stunden.
3. Bestätigen Sie die Auswahl mit der Taste . Danach wird die Tür sofort automatisch gesperrt.



ACHTUNG

Wenn die Tür nicht richtig geschlossen ist, beginnt die Pyrolyse nicht. Es ertönt ein akustisches Signal und auf der Anzeige blinkt das Symbol .

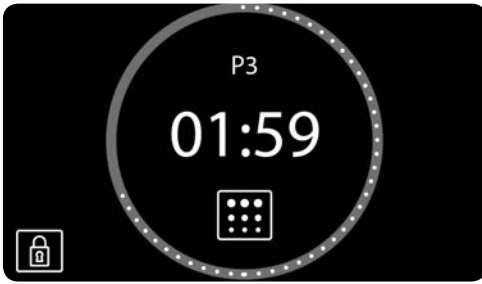

In diesem Fall müssen Sie die Tür richtig schließen, damit die Sperre eingeschaltet wird und die Pyrolyse beginnen kann.

4. Wenn die Tür gesperrt ist, leuchtet das Symbol  auf der Uhranzeige auf. Die restliche Zeit bis zur Beendigung der Pyrolyse wird angezeigt.



WICHTIG

Der Backofen ist programmiert und führt den Pyrolyse-Reinigungsvorgang durch.

In den ersten 10 Minuten können Sie den Beginn der Pyrolyse verzögern, indem Sie deren Endzeit programmieren. Dafür müssen Sie die Taste  berühren, um zum Menü der Optionen der Zeiteinstellung zu gelangen. Nachdem die Endzeit gewählt ist, bestätigen Sie sie mit der Taste .

Während der Pyrolyse kann keine andere Option der Zeiteinstellung gewählt werden. Sie können jedoch, wenn gewünscht, die Kindersicherung einschalten.

Versuchen Sie auch nicht, die Backofentür zu öffnen, da dadurch der Reinigungsprozess unterbrochen werden könnte.

5. Nach Beendigung der Pyrolyse-Reinigung ertönt ein akustisches Signal und das Symbol  blinkt. Auf der Uhranzeige erscheint 00:00.

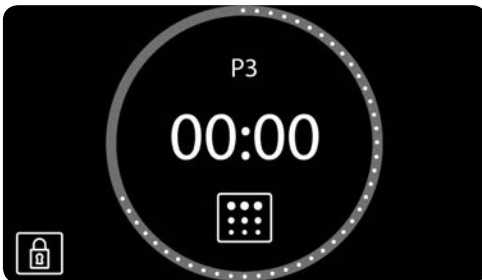

6. Drücken Sie eine beliebige Taste der Uhr, um das akustische Signal abzustellen.
7. Der Backofen schaltet sich automatisch ab.
8. Der Aufheizvorgang des Backofens ist beendet; dennoch ist der Backofen extrem heiß und kann nicht benutzt werden.

Solange der Ofen nicht abgekühlt ist, bleibt die Kühlung in Betrieb und das Symbol  leuchtet weiter.



WICHTIG

Aufgrund der hohen Temperaturen im Backofeninneren kann die Abkühldauer in Abhängigkeit von der Raumtemperatur schwanken.

9. Sobald Ihr Backofen abgekühlt ist, wird das Symbol  ausgeschaltet und die Tür wird entsperrt.
10. Öffnen Sie die Backofentür und entfernen Sie mit einem feuchten Tuch die während des Reinigungsvorgangs entstandene Asche. Reinigen Sie die schwer zugänglichen Stellen im Innenraum mit einem nicht-metallischen Topfkratzer.
11. Vergessen Sie nach der Reinigung des Backofeninnenraums nicht, die Halterungen und alle Zubehörteile wieder einzubauen.
12. Ihr Backofen ist jetzt für einen neuen Garvorgang betriebsbereit.





WICHTIG

Sollten Sie eine Störung bei der Programmierung oder Bedienung dieser Funktion feststellen, konsultieren Sie das Einbau- und Wartungshandbuch, das im Lieferumfang Ihres Backofens enthalten ist.

ABBRUCH DER PYROLYSE

Die Pyrolyse ist eine automatische Funktion und kann als solche nur durch Programmieren der Uhr gestartet werden. Um einen laufenden Pyrolyse-Vorgang abubrechen, muss die Programmierung des Backofens wie folgt annulliert werden:

1. Berühren Sie die Taste .
Die Pyrolyse wird unterbrochen.
2. Je nach Innentemperatur im Backofen können die beiden folgenden Situationen eintreten:
 - a) Gefährliche Innentemperatur: In diesem Fall bleibt die Tür so lange gesperrt, bis die Temperatur sichere Werte erreicht. Auf dem Bildschirm erscheint das Symbol .

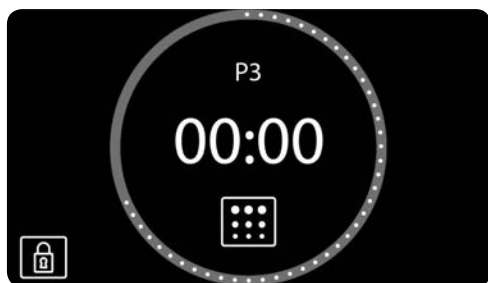

Sobald die Tür entsperrt ist und geöffnet werden kann, verschwindet das Symbol  und auf der Uhranzeige ist erneut die Uhrzeit zu sehen.

- b) Sichere Innentemperatur: Wenn die Innentemperatur im Backofen sicher ist, erfolgt die Entsperrung sofort.
3. Sichere Innentemperatur: Wenn die Backofeninnentemperatur sicher ist, erfolgt die Entsperrung sofort und der Backofen kehrt zur Startanzeige zurück.

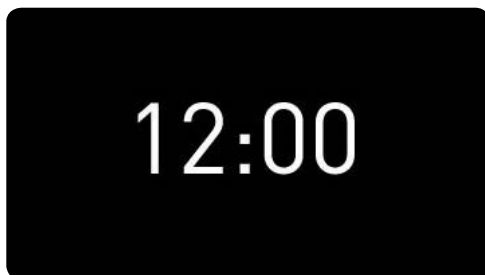

Beschrijving van de oven

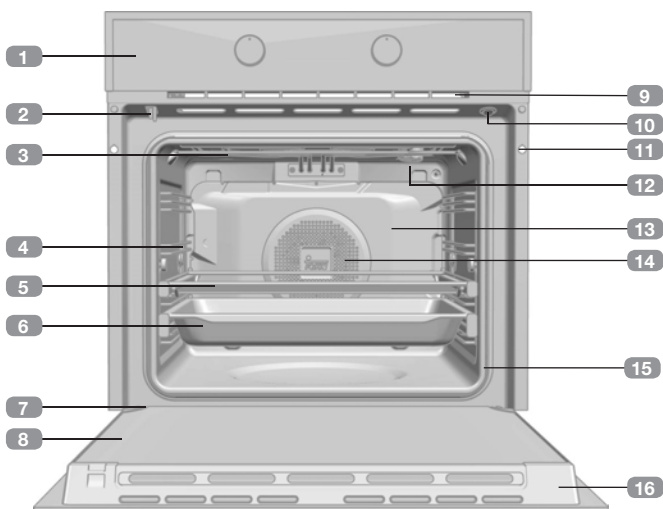

- 1 Bedieningspaneel
- 2 Vergrendeling / Deurschakelaar (alleen voor pyrolytische modellen)
- 3 Grillweerstand
- 4 Plaathouder
- 5 Braadrooster
- 6 Plaat
- 7 Scharnier
- 8 Binnenglas
- 9 Koelluchtuitlaat
- 10 Deurschakelaar (alleen voor niet-pyrolytische modellen)
- 11 Bevestiging aan meubel
- 12 Lamp
- 13 Achterpaneel
- 14 Turbine
- 15 Ovendichting
- 16 Deur

Bedieningspaneel

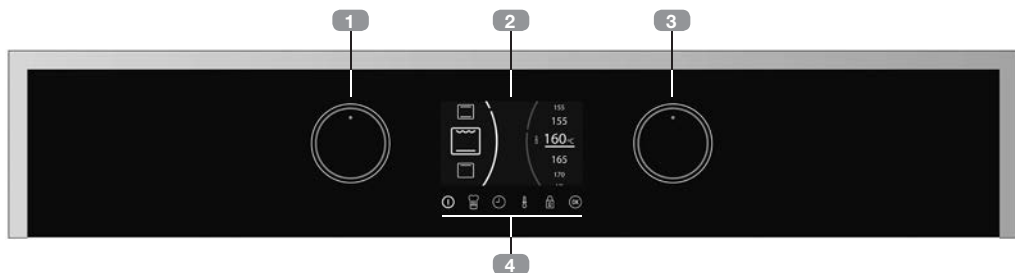



- 1 Knop om door de menu's aan de linkerkant van het scherm te bladeren. Bakmodusschakelaar
- 2 Display.
- 3 Knop om door de menu's aan de rechterkant van het scherm te bladeren. Bakinstellingenknop
- 4 Toetsen.

 **In- / Uitschakeling van de oven.**

 **Toegang tot de persoonlijke bakassistent (PBA)**

 **Toegang tot de timing- en programmeringsfuncties van de oven.**

 **Wijziging van de temperatuur van de oven.**

 **Inschakeling / Uitschakeling van de vergrendeling van het toetsbord / de deur, afhankelijk van het model.**

 **Bevestigingstoets. Uitschakelen / Inschakelen van het ovenlicht.**

Inschakelen en gelijkzetten

Als de oven voor het eerst op het elektriciteitsnet wordt aangesloten, verschijnt het logo gevolgd door de knipperende aanduiding 12:00.

Om met de oven te kunnen werken, moet de klok gelijkgezet worden.

Selecteer hiervoor de uren met de linkerknop en de minuten met de rechterknop.

Bevestig de selectie met de toets  of wacht een paar seconden.

U zult ter bevestiging een geluidssignaal horen, waarna de tijd ononderbroken op het scherm wordt weergegeven.

Om de tijd te veranderen:

Houd de toets  ingedrukt totdat de tijd gaat knipperen. Doe dit met de oven in de wachtstand (beginscherm). Volg de omschreven stappen om de tijd te wijzigen.



LET OP

De gevoeligheid van de touchtoetsen past zich continu aan de omgevingsomstandigheden aan. Wanneer u de oven op het elektriciteitsnet aansluit, dient u erop te letten dat het oppervlak van het bedieningspaneel schoon en obstakelvrij is.



Als het scherm niet op juiste wijze reageert nadat u het glas heeft aangeraakt, sluit dan de oven van het elektriciteitsnet af en sluit hem na een tijdje opnieuw aan. Op deze manier worden de sensoren automatisch ingesteld en reageren zij opnieuw nadat ze met de vinger worden aangeraakt.

DEMO-FUNCTIE (Speciale functie voor showrooms)

Met ingeschakelde DEMO-functie kunt u de oven bedienen zonder hem te verwarmen.

Deze functie wordt aanbevolen als de oven in een showroom wordt geplaatst met aansluiting op het elektriciteitsnet.

Inschakeling van de DEMO-functie.

Voordat u de klok gelijk zet, dient u eerst op de toetsen  en  te drukken totdat op het scherm de aanduiding «DEMO Mode ON» verschijnt.

Zet daarna de ovenklok gelijk.

Het woord «DEMO» verschijnt continu op het scherm en de oven kan normaal worden gebruikt, maar wordt niet warm.

Om de DEMO-functie uit te schakelen dient de oven van het elektriciteitsnet te worden afgesloten.



LET OP

Bij een stroomonderbreking wordt de hele programmering van de elektronische klok gewist.

De aanduiding 12:00 verschijnt.

U kunt de klok gelijkzetten volgens de voornoemde aanwijzingen.

Als de ovendeur voor de stroomonderbreking vergrendeld was, gaat het vergrendelingsymbool branden totdat de deur wordt ontgrendeld.

Dit kan een paar minuten duren, afhankelijk van de temperatuur van de oven. In deze tijd kan de klok niet worden gelijkgezet.

Nadat de ovendeur is ontgrendeld kunt u de klok gelijkzetten volgens de voornoemde aanwijzingen.

Beschrijving van het bedieningsscherm

Hierna wordt beschreven welke informatie op het display van uw oven verschijnt en hoe deze wordt weergegeven.

BEGINSCHERM / RUSTSTAND

Dit scherm verschijnt wanneer de oven niet in werking is, maar wel op het elektriciteitsnet is aangesloten.

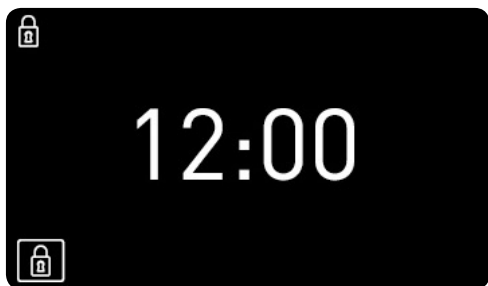

Als de vergrendeling van het toetsenbord of van de deur is ingeschakeld, verschijnen de symbolen  en  links op het scherm.

Als u de minuterie heeft geprogrammeerd, dan toont het scherm niet langer de tijd maar telt het af, zoals in de volgende afbeelding wordt weergegeven.

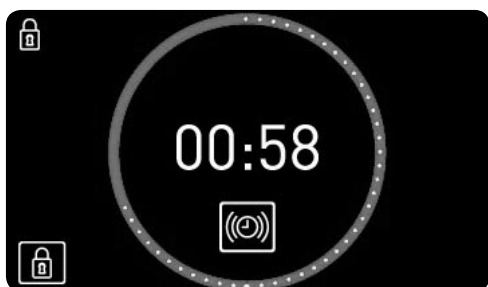

SELECTIESCHERM



Selecteer een functie.

Tijdens de selectie van een bakfunctie, automatisch recept of klokfunctie, is het scherm in tweeën gedeeld:

LINKERDEEL. In dit deel van het scherm worden de bakfuncties, automatische recepten of klokfuncties die geselecteerd kunnen worden getoond.

Draai, om een van deze functies te selecteren, aan de linkerknop totdat de gewenste functie vergroot verschijnt en bevestig de selectie met de toets  (als u geen toets indrukt, bevestigt de oven na een aantal seconden de selectie automatisch).

RECHTERDEEL. In dit deel van het scherm worden de in te stellen waarden afhankelijk van de geselecteerde functie getoond: temperatuur, gewicht, duur, eindtijd...

Draai, om een waarde te kiezen, aan de rechterknop totdat de gewenste waarde vergroot verschijnt en bevestig de keuze met de toets  (als u geen toets indrukt, bevestigt de oven na een aantal seconden de selectie automatisch).

BAKSCHERM

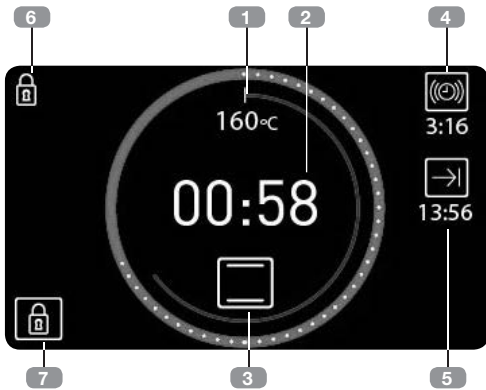

Tijdens het bakken verschijnt de informatie over de situatie van de oven op het scherm, rondom de twee middelste cirkels:

Binnenste temperatuurcirkel. In het rood. Deze vertegenwoordigt op schaal de geselecteerde temperatuur.

Buitenste tijdcirkel.

- In het rood wanneer wordt getoond hoelang de oven al bezig is met bakken. Om de 2 minuten verschijnt er een wit punt.
- In het blauw als wordt getoond hoelang het nog duurt voordat het bakproces is afgelopen (aftellen). Om de 2 minuten verdwijnt er een wit punt.

Binnen deze cirkels vindt u de volgende informatie over het bakproces:

- 1. Geselecteerde temperatuur.** Het symbool °C knippert totdat de geselecteerde temperatuur wordt bereikt en mits de oven warmte overbrengt naar het voedsel.

2. Baktijd.

- Als u de klok niet heeft geprogrammeerd, wordt getoond hoelang de oven bezig is met bakken en is de tijdcirkel rood.
- Als de oven wel is geprogrammeerd, dan wordt getoond hoelang het nog duurt voordat het bakproces is voltooid (aftellen) en is de tijdcirkel blauw.
- Als de oven is geprogrammeerd, maar hij bevindt zich in de wachtstand (is nog niet begonnen met het bakproces), dan wordt de geprogrammeerde totale duur van het bakproces getoond.

3. Geselecteerde bakfunctie of automatisch recept.

Buiten de cirkels vindt u de volgende informatie over de aanvullende functies:

RECHTERKANT VAN HET SCHERM. Als er tijdsfuncties zijn geprogrammeerd dan wordt de informatie met betrekking tot deze functies aan de rechterkant van het scherm getoond.

- 4. Kookwekker:** Aftellen voor de beëindiging van de geprogrammeerde melding.

- 5. Eindtijd.**

LINKERKANT VAN HET SCHERM. Informatie over geactiveerde veiligheidsfuncties.

- 6. Vergrendeling van het toetsenbord.** Deze licht op als de kinderbeveiliging is geactiveerd.

- 7. Deurvergrendeling. ALLEEN VOOR PYROLYTISCHE MODELLEN.** Deze licht op als de handmatige deurvergrendeling is geactiveerd.

Bakken met de traditionele functies

FUNCTIES VAN DE OVEN



INFORMATIE

Raadpleeg voor een beschrijving van het gebruik van elk van de functies de bij de oven meegeleverde bakgids.



UITSCHAKELING



CONVENTIONEEL



CONVENTIONEEL MET TURBINE



GRILL EN OVENVLOER



MAXIGRILL



GRILL



OVENVLOER



PIZZA



TURBO

ECO ECO



OP EEN ZACHT VUURTJE



DEEG LATEN RIJZEN



ONTDOOIEN



HYDROCLEAN



PYROLYSE (afhankelijk van het model)



Functies met automatische snelle voorverwarming

BAKKEN MET DE TRADITIONELE FUNCTIES



Funcieselectie.

Schakel de oven in door op de toets  te drukken.

Draai aan de linkerknop totdat de gewenste functie vergroot wordt weergegeven.

Vervolgens verschijnt rechts de aanbevolen temperatuur voor de gekozen functie.



Als u dat wilt, kunt u de temperatuur veranderen door aan de rechterknop te draaien.

Bevestig de selectie met de toets .

De oven begint het bakproces.

U kunt op elk moment van het bakproces:

- **De bakfunctie veranderen door** aan de linkerknop te draaien.

- **De baktemperatuur veranderen door** aan de rechterknop te draaien.
- **Een melding of baktijd/bakeinde programmeren.** Door de toets  aan te raken.
- **De geprogrammeerde meldingen of baktijd/bakeinde veranderen.** Door de toets  aan te raken.



INFORMATIE

Bekijk voor het programmeren of het wijzigen van een programmering de paragraaf «Tijdsprogrammering van het bakproces» die u later in deze gebruiksaanwijzing zult vinden.

AUTOMATISCHE SNELLE VOORVERWARMING

































De genoemde functies zijn voorzien van een automatische snelle voorverwarming.

Tijdens de snelle voorverwarming licht het symbool  op.

Het wordt aanbevolen om pas voedsel in de oven te doen als dit symbool uitgaat.

Bakken en koken met de Persoonlijke Bakassistent (PBA)

AUTOMATISCHE RECEPTEN VAN DE OVEN

GEVOGELTE 	 KIP	
	 EEND	
	 GANS	
	 KALKOEN	
	 BOUTEN	
VLEESGERECHTEN 	 SPEENVARKEN	
	 OSSENVLEES	
	 LAM	
	 KARBONADES	
VISGERECHTEN 	 HEEK	
	 ZALM	
BROOD 	 WITBROOD	
	 BRUIN BROOD	
	 VOLKORENBROOD	
PIZZA 	 PIZZA DIKKE BODEM	
	 PIZZA DUNNE BODEM	
NAGERECHTEN 	 CAKE	
	 GROOT VRUCHTENGEBAK	
	 KLEIN VRUCHTENGEBAK	
	 GEBAK OP BAKPLAAT	

 Recepten waarbij de oven leeg moet worden voorverwarmd.

 Recepten waarbij het voedsel moet worden omgedraaid.

BAKKEN MET DE PERSOONLIJKE BAKASSISTENT

Schakel de oven in door op de toets  te drukken.



Receptselectie.

Druk op de toets .

Draai aan de linkerknop totdat het type voedsel dat u wilt klaarmaken vergroot wordt weergegeven.

Aan de rechterkant van het scherm worden vervolgens de recepten getoond die beschikbaar zijn voor het geselecteerde type voedsel. Selecteer met de rechterknop het gewenste recept en bevestig de keuze met de toets .

Aan de rechterkant van het scherm verschijnt vervolgens de informatie die de oven nodig heeft om het bakproces te programmeren.

Afhankelijk van het geselecteerde recept, vraagt de oven om de volgende informatie in te voeren:

GEWICHT VAN HET VOEDSEL: Kies met de rechterknop en bevestig de keuze met de toets .

TEMPERATUUR: Bevestig de door het recept voorgestelde temperatuur of selecteer met de rechterknop een andere temperatuur en bevestig deze met de toets .

GAARHEID: Bij sommige gerechten kunt u de gaarheid kiezen:

- **HIGH:** Erg doorbakken
- **MEDIUM:** À point
- **LOW:** Bijna rauw

Als alle parameters zijn gekozen, bevestig dan met de toets .

De oven begint het bakproces en het selectiescherm maakt plaats voor het bakscherm, waarop de volgende informatie wordt weergegeven:

- Geselecteerde baktemperatuur
- Resterende baktijd
- Geselecteerd recept

Nadat het bakproces is voltooid gaat er ongeveer 90 seconden een geluidssignaal af en knippert op het scherm het symbool van het bakproces. Raak een willekeurige toets aan om het geluid uit te zetten.

De oven gaat automatisch uit.



INFORMATIE

Gedurende de eerste tien minuten van het bakproces kunt u het gewicht en de gaarheid nog wijzigen of een eindtijd voor het bakproces programmeren.

Daarna blijven deze waarden onafgebroken branden en kunnen ze niet meer worden gewijzigd.

Druk om deze bakwaarden te wijzigen de toets  in en de oven gaat weer terug naar het selectiescherm.

Volg de hiervoor genoemde stappen op.

U kunt op elk moment van het bakproces:

De baktemperatuur wijzigen door de toets  in te drukken. Bevestig met de toets .

Een melding programmeren. Door de toets  aan te raken.

Een geprogrammeerde melding wijzigen. Door de toets  aan te raken.

Volg voor het programmeren of het wijzigen van een programmering de instructies op van de paragraaf «Tijdsprogrammering van het bakproces» die u later in deze gebruiksaanwijzing zult vinden.

LEEG VOORVERWARMEN

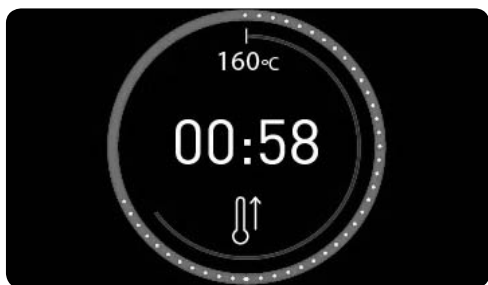

Voor de in de tabel met het symbool  aangeduide recepten moet het voedsel in een reeds warme oven worden geïntroduceerd.

Als u een van deze recepten selecteert, wordt bij aanvang van het bakproces het symbool  op het scherm getoond. Als de oven de baktemperatuur heeft bereikt, gaat het symbool knipperen en klinkt er een alarm die erop wijst dat het voedsel in de oven kan worden geïntroduceerd.

Het alarm gaat automatisch weer uit als u de ovendeur opent om het gerecht in de oven te doen. Op het bakscherm wordt de resterende baktijd weergegeven.

OMDRAAIEN VAN HET VOEDSEL

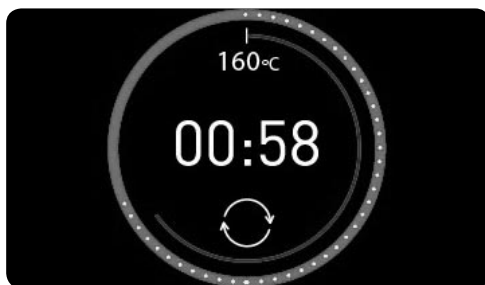

Voor de in de tabel met het symbool  aangeduide recepten moet het voedsel tijdens het bakproces worden omgedraaid.

De oven meldt met een geluidssignaal wanneer u dit moet doen en op het bakscherm verschijnt het symbool .

Het alarm gaat automatisch weer uit als u de ovendeur opent om het voedsel om te draaien.

Timing van de oven

TIMINGOPTIES

U heeft de volgende opties om de tijd van een bakproces te programmeren:

 **Kookwekker:** Er wordt een alarm voortgebracht als de geprogrammeerde tijd is afgelopen. Het bakproces stopt NIET als de tijd voorbij is. Ook kan er een melding worden voortgebracht als de oven niet bezig is met een bakproces.



INFORMATIE

U kunt op elk willekeurig moment, of de oven nu wel of niet bezig is met een bakproces, een melding programmeren.

De rest van de timingopties zijn alleen beschikbaar als de oven bezig is met bakken.

 **Baktijd:** Hiermee kan worden geselecteerd hoelang de oven zal bakken.

Na afloop van de geprogrammeerde tijd gaat een alarm af, het symbool  gaat knipperen en de oven stopt automatisch met verwarmen.

Druk op een willekeurige toets om het alarm te stoppen en de oven uit te zetten.

 **Eindtijd van het bakproces:** Hiermee selecteert u het tijdstip waarop de oven zal stoppen met bakken.

Als het geprogrammeerde tijdstip wordt bereikt gaat een alarm af, het symbool  gaat knipperen en de oven stopt automatisch met verwarmen.

Druk op een willekeurige toets om het alarm te stoppen en de oven uit te zetten.

Begin van een van tevoren geprogrammeerd bakproces (|→) Duur + (→) Eindtijd van het bakproces): Hiermee kunt u de oven programmeren zodat het bakproces automatisch begint en tevens automatisch wordt uitgeschakeld, nadat de geprogrammeerde baktijd voorbij is.



INFORMATIE

Om deze optie te programmeren moeten de duur en achtereenvolgens de eindtijd van het bakproces worden ingesteld.

U heeft op elk willekeurig moment tijdens het bakproces toegang tot de programmeringsopties.

Zo kunt u ook een reeds ingestelde programmering weer wijzigen.



INFORMATIE

Als u een automatisch recept heeft geselecteerd, bepaalt de oven automatisch de duur van het bakproces. Daarom is deze optie niet beschikbaar.

In dit geval is het wel mogelijk om:

De eerste tien minuten van het bakproces de eindtijd te programmeren.

Op elk ogenblik de minuterie te programmeren.

PROGRAMMEREN VAN TIMINGOPTIES

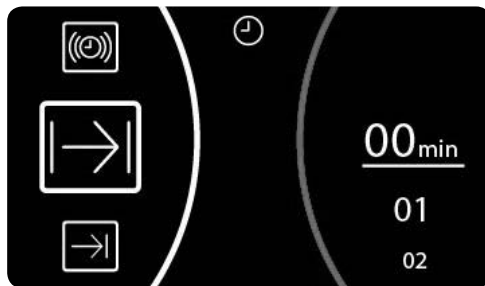

Programmering van de duur van het bakproces.

- 1 Druk op de toets om toegang te krijgen tot het timingoptiemenu.
- 2 Draai aan de linkerknop om de gewenste programmeringsoptie te selecteren.
- 3 Draai aan de rechterknop om de duur of de eindtijd naargelang de gekozen optie te selecteren.



INFORMATIE

De oven staat niet toe dat er een eindtijd vóór de huidige tijd wordt geselecteerd.

Als u een eindtijd programmeert, wordt in het midden de huidige tijd getoond. Dit om de keuze te vergemakkelijken.

- 4 Bevestig de selectie met de toets .
- 5 Hierna verschijnt het bakscherm weer. U kunt de geprogrammeerde tijden rechts van de middencirkel zien.

Veiligheidsfuncties

KINDERBEVEILIGING (VERGREDELING VAN HET BEDIENINGSPANEEL)

Deze functie kan op elk willekeurig moment worden ingeschakeld:

- **Met uitgeschakelde oven.** Door de kinderbeveiliging kan de oven niet worden ingeschakeld als op de toets wordt gedrukt.

- **Tijdens het gebruik van de oven.** Als u de functie inschakelt terwijl de oven in werking is of zich in de wachtstand bevindt, worden het toetsenbord en de knoppen vergrendeld en kan geen van de bakwaarden worden gewijzigd.

Druk **om de functie in te schakelen** net zolang op de toets totdat u een piepton hoort

en het symbool  op het scherm verschijnt. Het bedieningspaneel is nu vergrendeld.

Druk **om de functie uit te schakelen** net zolang op de toets  totdat u een pieptoon hoort en het symbool  verdwijnt.

HANDMATIGE DEURVERGREDELING

Alleen beschikbaar bij pyrolytische modellen.

Bij de pyrolytische modellen is de kinderbeveiliging voorzien van deurvergrendeling. Hiermee wordt vermeden dat de deur kan worden geopend.

Om de deur te openen moet eerst de kinderbeveiliging worden uitgeschakeld volgens de voornoemde aanwijzingen.

Teka Hydroclean® functie

Met deze functie kunnen vet- en vuilresten die aan de overwanden zijn blijven kleven gemakkelijk worden schoongemaakt

Laat vuil niet ophopen. Op die manier kan de oven gemakkelijker worden schoongemaakt. Maak de oven regelmatig schoon.

DE TEKA HYDROCLEAN® FUNCTIE PROGRAMMEREN



LET OP

Giet geen water in de warme oven. Dit kan het email van uw oven beschadigen.

Voer de cyclus altijd met afgekoelde oven uit. Als u dit met een te warme oven doet, kan het resultaat minder goed zijn en kan bovendien het email worden beschadigd.

Verwijder eerst de platen en alle accessoires uit de oven, ook de steunen voor de bakplaten of de uitschuifbare rails



LET OP

Zorg ervoor dat de ovendeur goed gesloten is voordat u de pyrolyse in werking stelt. Als de deur niet goed gesloten is, wordt hij niet vergrendeld. Er gaat dan een alarm af en op het scherm knippert het symbool .

Als dit gebeurt moet u de deur goed afsluiten, waarna het alarm uitgaat en de vergrendeling in werking treedt.

Als u de deur niet wilt vergrendelen, schakel dan de kinderbeveiliging uit.

Volg hiervoor de instructie in de installatie en onderhoudshandleiding die bij uw oven wordt meegeleverd.

- 1 Spreid, als de oven is afgekoeld, een doekje uit op de ovenvloer.

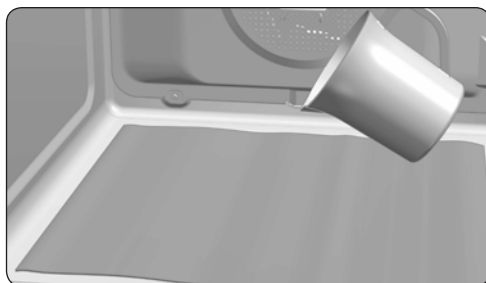



- 2 Giet langzaam 200 ml water in de opening van de oven.



INFORMATIE

Doe voor een beter resultaat een lepeltje mild afwasmiddel in het glas water voordat u het over het keukendoekje uitgiet

- 3 Zet de oven aan, draai aan de linkerknop om de functie  te selecteren en bevestig met .

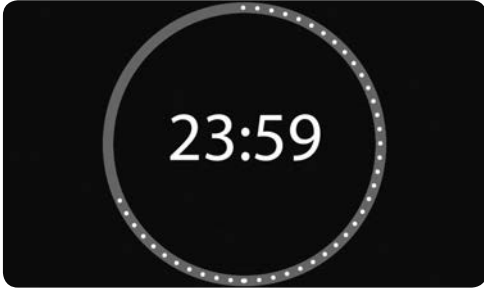

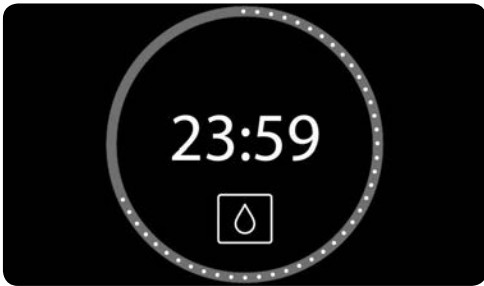

- 4 Vervolgens hoort u een geluidssignaal ter bevestiging van het feit dat de Teka Hydroclean® functie in werking is gesteld.

Op het scherm verschijnt het symbool  en de resterende tijd voordat de functie is voltooid.



BELANGRIJK

De duur van deze functie kan niet gewijzigd worden. Zet de oven uit met de toets  om het bakproces eerder te beëindigen.

- 5 Wanneer de eindtijd is bereikt, gaat de oven uit. Het alarm gaat af en het symbool  knippert snel.



BELANGRIJK

Open de ovendeur pas als de Hydroclean® functie is afgelopen.

De afkoelfase is nodig voor de juiste werking van de Hydroclean® functie.

- 6 Raak een willekeurige toets aan om het geluidssignaal en het symbool  uit te schakelen.
- 7 De oven gaat automatisch uit.
- 8 De oven is klaar om de vuilresten en het overtollige water met een keukendoekje te verwijderen.

De Hydroclean® functie wordt op lage temperatuur uitgevoerd. De afkoeltijden kunnen echter variëren naargelang de omgevingstemperatuur.



LET OP

Zorg ervoor dat de temperatuur veilig is voordat u de binnenwanden van de oven direct aanraakt.

Als het na de Hydroclean® functie nodig is om de oven nog grondiger schoon te maken, gebruik dan neutrale reinigingsmiddelen en niet-schurende sponzen.

Pyrolytische zelfreinigingsfunctie



LET OP

Lees voordat u de pyrolytische reinigingscyclus gaat uitvoeren aandachtig de veiligheidsinstructies die u aan het begin van de installatie- en onderhoudshandleiding vindt.

Met deze functie kunt u een pyrolytische reiniging uitvoeren. Door de hoge temperaturen die in de oven worden bereikt, ontstaat tijdens deze reinigingscyclus een carbonisatieproces van de opgehoopte vetten.

Over het algemeen wordt aanbevolen om telkens na 4 à 5 bakprocessen een pyrolyserreiniging uit te voeren en het programma te gebruiken dat geschikt is voor de hoeveelheid opgehoopt vuil in de oven. Hoe viezer de oven, hoe langer het programma moet duren.

Tijdens de pyrolyserreiniging blijft de ovenverlichting uitgeschakeld

DE PYROLYSEFUNCTIE PROGRAMMEREN



BELANGRIJK

Verwijder voor de pyrolyse alle accessoires en serviesgoed uit de oven, met inbegrip van de bakplaathouders en/of telescoopgeleiders. Volg hiervoor de instructie in de installatie- en onderhoudshandleiding die bij uw oven wordt meegeleverd.



LET OP

Verwijder gelect vocht of buitensporige vuilresten uit de oven, want deze kunnen tijdens het pyrolyseproces ontvlammen waardoor brandgevaar ontstaat.



LET OP

Zorg er voordat u de pyrolyse in werking stelt voor dat de ovendeur op juiste wijze is gesloten.

- 1 Zet de oven aan en selecteer met de linker-knop de functie Pyrolyse

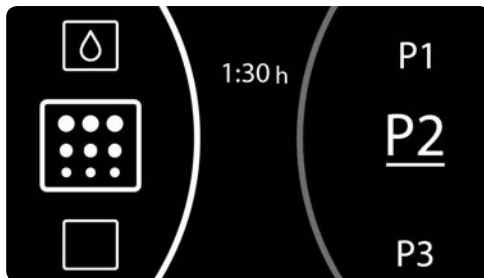

- 2 Selecteer met de rechterknop het pyrolyseprogramma dat het geschiktst is voor de hoeveelheid vuil in uw oven:

P1: Milde pyrolyse. Duur 1 uur.

P2: Normale pyrolyse. Duur 1 uur en 30 minuten.

P3: Intensieve pyrolyse. Duur 2 uur

3. Bevestig de selectie met de toets . Onmiddellijk daarna begint de automatische deurvergrendeling.



LET OP

Als de deur niet goed gesloten is, start de pyrolyse niet. Er gaat een alarm af en op het scherm gaat het symbool knipperen.

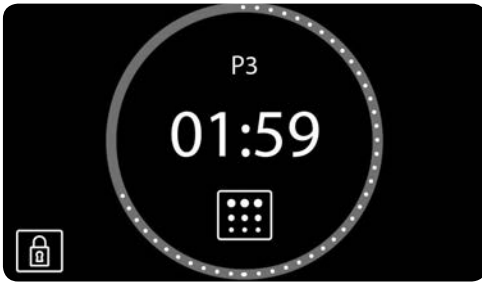

Als dit gebeurt, sluit dan de deur goed zodat de vergrendeling in werking treedt en de pyrolyse kan beginnen.

4. Als de deur is vergrendeld, licht het symbool op het scherm van de klok op en wordt de resterende tijd voor de beëindiging van de pyrolyse getoond.



BELANGRIJK

De oven is geprogrammeerd en voert een pyrolytische reinigingscyclus uit.

Gedurende de eerste tien minuten kunt u het begin van de pyrolyse uitstellen door de eindtijd ervan te programmeren. Druk hiervoor op de toets  om toegang te krijgen tot het timingoptiemenu. Als de eindtijd is gekozen, bevestig dan met de toets .

Tijdens de pyrolyse kunt u geen andere timingoptie selecteren. U kunt wel de kinderbeveiliging inschakelen, als u dat wilt.

Probeer de ovendeur niet te openen, want dat zou het reinigingsproces kunnen onderbreken.

5. Als de pyrolytische zelfreiniging is afgerond hoort u een geluidssignaal, gaat het symbool  knipperen en verschijnt 00:00 op het scherm van de klok.

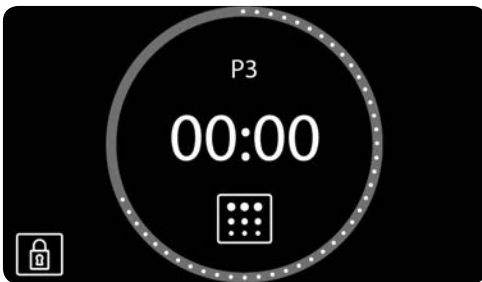

6. Druk op een willekeurige toets van de klok om het alarm te stoppen.
7. De oven gaat automatisch uit.
8. Het verwarmingsproces van de oven is voltooid, maar de oven is nog te warm en kan niet worden gebruikt. Het verwarmingsproces van de oven is voltooid, maar de oven is nog te warm en kan niet worden gebruikt.

Zolang de oven niet is afgekoeld, blijft de koeling werken en blijft het symbool  branden.



BELANGRIJK

Door de hoge temperaturen in de oven kan de duur van het afkoelproces variëren afhankelijk van de omgevingstemperatuur.

9. Nadat uw oven is afgekoeld gaat het symbool  uit en wordt de deur ontgrendeld.
10. Doe de ovendeur open en maak de binnenkant schoon met een vochtige doek om de tijdens de reinigingscyclus ontstane as te verwijderen. Moeilijk bereikbare delen van de oven dienen schoongemaakt te worden met een niet-metalen vezelspons.
11. Vergeet niet de steunen en de accessoires weer te installeren zodra de oven schoon is.
12. De oven is nu weer klaar om gebruikt te worden.



BELANGRIJK

Als u een incident opmerkt bij de programmering en de bediening van deze functie, raadpleeg dan de installatie- en onderhoudshandleiding die bij uw oven is geleverd.

ANNULEREN VAN DE PYROLYSE

De pyrolyse is een automatische functie en hoeft dan ook alleen maar d.m.v. de programmering van de klok in werking gesteld te worden. Als u een pyrolyse wilt onderbreken, moeten de programma-instellingen van de oven worden gewist volgens de onderstaande aanwijzingen:

1. Druk op de toets .

De pyrolyse zal nu stoppen.

2. Afhankelijk van de temperatuur in de oven kunnen er zich twee situaties voordoen:

- a) Gevaarlijke temperatuur van de oven: In dit geval blijft de deur vergrendeld totdat de temperatuur veilige waarden heeft bereikt. Op het scherm verschijnt het symbool .

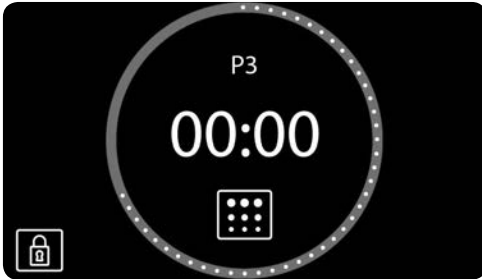

Nadat de deur is ontgrendeld en kan worden geopend, verdwijnt het symbool  en wordt opnieuw de tijd op het scherm van de klok weergegeven.

- b) Veilige temperatuur van de oven: als de temperatuur van de oven veilig is, wordt hij onmiddellijk ontgrendeld.
3. Veilige temperatuur van de oven: Als de temperatuur van de oven veilig is, wordt hij onmiddellijk ontgrendeld en gaat de oven terug naar het ruststandscherm.

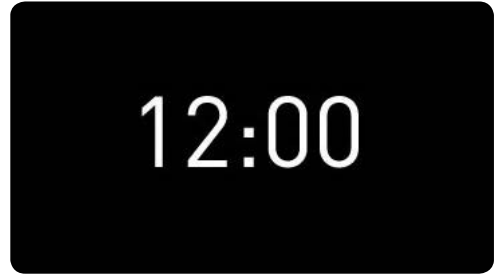

Περιγραφή του φούρνου

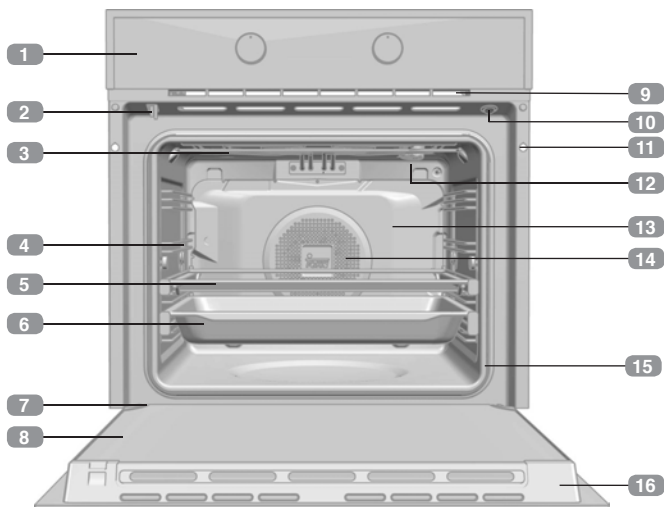





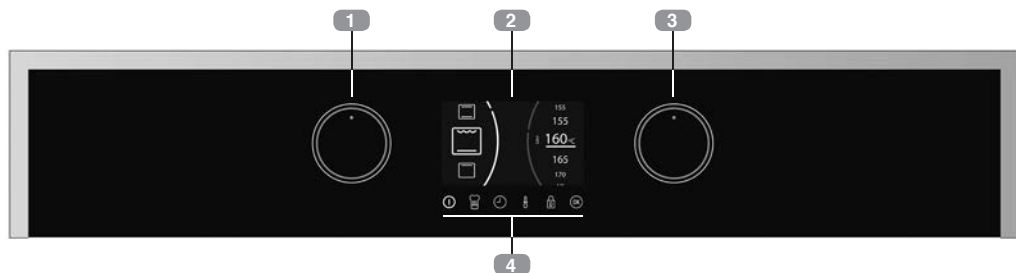

- 1 Πίνακας χειρισμού
- 2 Διακόπτης κλειδώματος πόρτας (μόνο για μοντέλα με σύστημα πυρόλυσης)
- 3 Αντίσταση γκριλ
- 4 Στηρίγματα ταψιών
- 5 Σχάρα
- 6 Ταψί
- 7 Μεντεσές
- 8 Εσωτερικό κρύσταλλο
- 9 Έξοδος αέρα ψύξης
- 10 Διακόπτης πόρτας (μόνο για μοντέλα ΧΩΡΙΣ σύστημα πυρόλυσης)
- 11 Στερέωση στο έπιπλο
- 12 Λαμπτήρας
- 13 Πίσω πάνελ
- 14 Μοτέρ με φτερωτή παραγωγής αέρα
- 15 Λάστιχο φούρνου
- 16 Πόρτα

Πίνακας χειρισμού



- 1 Διακόπτης για μετακίνηση στα μενού της αριστερής πλευράς της οθόνης. Διακόπτης επιλογής λειτουργίας μαγειρέματος.
- 2 Οθόνη.
- 3 Διακόπτης για μετακίνηση στα μενού της δεξιάς πλευράς της οθόνης. Διακόπτης επιλογής ρυθμίσεων μαγειρέματος.
- 4 Πλήκτρα.

- | | |
|--|--|
| <p> Ενεργοποίηση/ Απενεργοποίηση φούρνου</p> <p> Πρόσβαση στις προγραμματισμένες συνταγές (Personal Cooking Assistant) (PCA)</p> <p> Πρόσβαση στις λειτουργίες προγραμματισμού ώρας και χρόνου του φούρνου</p> | <p> Τροποποίηση της θερμοκρασίας του φούρνου</p> <p> Ενεργοποίηση / Απενεργοποίηση ασφάλισης πληκτρολογίου / πόρτας ανάλογα με το μοντέλο</p> <p> Πλήκτρο επικύρωσης Ενεργοποίηση/ Απενεργοποίηση εσωτερικού φωτισμού.</p> |
|--|--|

Έναρξη λειτουργίας και ρύθμιση της ώρας

Μόλις ο φούρνος συνδεθεί για πρώτη φορά στην παροχή ρεύματος, θα εμφανιστεί το λογότυπο και, στη συνέχεια, η ένδειξη 12:00 που θα αναβοσβήνει.

Για να μπορεί να τεθεί σε λειτουργία ο φούρνος, θα πρέπει να ρυθμιστεί το ρολόι.

Επιλέξτε τις ώρες με τον αριστερό διακόπτη και τα λεπτά με τον δεξί.

Επικυρώστε τις επιλογές σας με το πλήκτρο  ή περιμένετε λίγα δευτερόλεπτα.

Θα ακουστεί ένα ηχητικό σήμα ως επιβεβαίωση της ρύθμισης της ώρας στην οθόνη.

Για να αλλάξετε την ώρα:

Με τον φούρνο σε λειτουργία αναμονής (οθόνη έναρξης) κρατήστε πατημένο το πλήκτρο  ώσπου η ώρα να αρχίσει να αναβοσβήνει. Ακολουθήστε τα παραπάνω βήματα για να αλλάξετε την ώρα.



ΠΡΟΣΟΧΗ

Η ευαισθησία των πλήκτρων αφής προσαρμόζεται διαρκώς στις περιβαλλοντικές συνθήκες. Όταν συνδέετε τον φούρνο στο ρεύμα, φροντίστε ώστε η επιφάνεια του πίνακα χειρισμού να είναι καθαρή και χωρίς εμπόδια.



Αν, το ρολόι δεν ανταποκρίνεται σωστά όταν αγγίζετε τα πλήκτρα, θα πρέπει να αποσυνδέσετε τον φούρνο από το ρεύμα και να τον συνδέσετε ξανά μετά από λίγο. Με τον τρόπο αυτό, οι αισθητήρες θα ρυθμίσουν αυτόματα και θα ανταποκριθούν πάλι κατάλληλα όταν τους αγγίξετε.

ΛΕΙΤΟΥΡΓΙΑ DEMO (Ειδική λειτουργία επίδειξης για εκθέσεις)

Όταν ενεργοποιείται η λειτουργία DEMO, ο φούρνος μπορεί να υποστεί χειρισμό χωρίς να ζεσταίνεται.

Σας συνιστούμε να ενεργοποιήσετε αυτόν τον τρόπο λειτουργίας αν ο φούρνος πρόκειται να εγκατασταθεί σε έκθεση για επίδειξη και έχει πρόσβαση σε παροχή ρεύματος.

Ενεργοποίηση λειτουργίας DEMO

Προτού ρυθμίσετε την ώρα στο ρολόι, πατήστε ταυτόχρονα τα πλήκτρα  και  ώσπου να εμφανιστεί στην οθόνη η ένδειξη «DEMO Mode ON».

Στη συνέχεια, ρυθμίστε την ώρα στον φούρνο.

Η λέξη «DEMO» θα εμφανίζεται αδιάλειπτα στην οθόνη και ο φούρνος μπορεί να χρησιμοποιηθεί κανονικά, χωρίς όμως να ζεσταθεί.

Για να απενεργοποιήσετε την λειτουργία DEMO, θα πρέπει να αποσυνδέσετε τον φούρνο από το ρεύμα.



ΠΡΟΣΟΧΗ

Σε περίπτωση διακοπής ρεύματος, θα σβηστεί όλος ο προγραμματισμός του ηλεκτρονικού σας ρολογιού.

Θα εμφανιστεί η ένδειξη 12:00.

Μπορείτε να ρυθμίσετε την ώρα στο ρολόι ακολουθώντας τις προαναφερόμενες οδηγίες.

Αν η πόρτα του φούρνου ήταν ήδη κλειδωμένη πριν τη διακοπή ρεύματος, το σύμβολο κλειδώματος της πόρτας θα ανάβει ώσπου η πόρτα να απεμπλακεί.

Η διαδικασία αυτή μπορεί να διαρκέσει αρκετά λεπτά, ανάλογα με τη θερμοκρασία στο εσωτερικό του φούρνου, και σε όλο αυτό το διάστημα δεν θα μπορέσετε να ρυθμίσετε το ρολόι.

Μετά την απεμπλοκή της πόρτας, θα μπορέσετε να ρυθμίσετε την ώρα στο ρολόι ακολουθώντας τις παραπάνω οδηγίες.



Περιγραφή του πίνακα χειρισμού

Ακολουθεί περιγραφή των πληροφοριών που εμφανίζονται στην οθόνη του φούρνου σας και ο τρόπος παρουσίασής τους.

ΟΘΟΝΗ ΕΝΑΡΞΗΣ / ΑΝΑΜΟΝΗΣ

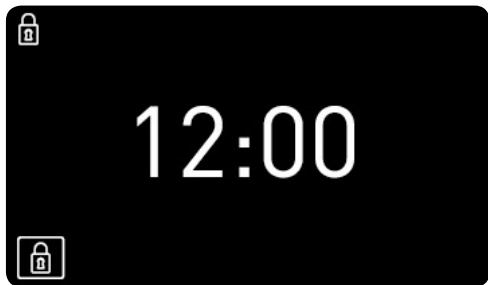
Η οθόνη αυτή θα εμφανιστεί όταν ο φούρνος σας δεν εκτελεί κάποια λειτουργία αλλά είναι συνδεδεμένος στο ρεύμα.



Αν έχει ενεργοποιηθεί το κλείδωμα του πληκτρολογίου ή της πόρτας, θα εμφανιστούν τα σύμβολα  και  στην αριστερή πλευρά της οθόνης.

Αν έχει προγραμματιστεί να ηχήσει ειδοποίηση, η οθόνη δεν θα εμφανίζει την ώρα αλλά την αντίστροφη μέτρηση ως την ειδοποίηση, όπως φαίνεται στην παρακάτω εικόνα.

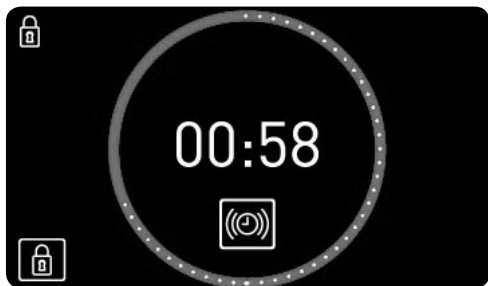

ΟΘΟΝΗ ΕΠΙΛΟΓΗΣ

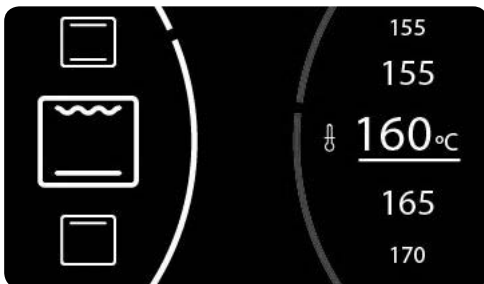

Επιλογή λειτουργίας

Κατά την επιλογή μιας λειτουργίας μαγειρέματος, αυτόματης συνταγής ή λειτουργίας ρολογιού, η οθόνη θα χωριστεί σε δύο τμήματα:

ΑΡΙΣΤΕΡΟ ΤΜΗΜΑ: Σε αυτήν την περιοχή της οθόνης εμφανίζονται οι λειτουργίες μαγειρέματος, αυτόματες συνταγές ή λειτουργίες προγραμματισμού του ρολογιού που μπορείτε να επιλέξετε.

Για να επιλέξετε κάποια από αυτές, στρέψτε τον αριστερό διακόπτη ώσπου να εμφανιστεί η λειτουργία που επιθυμείτε. Επικυρώστε την επιλογή σας με το πλήκτρο  (αν δεν πατήσετε κανένα πλήκτρο, η επιλογή θα επικυρωθεί αυτόματα μετά από λίγα δευτερόλεπτα).

ΔΕΞΙ ΤΜΗΜΑ: Σε αυτήν την περιοχή της οθόνης εμφανίζονται οι τιμές που πρέπει να ρυθμιστούν ανάλογα με τον επιλεγμένο τρόπο λειτουργίας: θερμοκρασία, βάρος, διάρκεια, ώρα λήξης, κλπ.

Για να επιλέξετε μια τιμή, στρέψτε τον δεξιά διακόπτη ώσπου να εμφανιστεί η τιμή που επιθυμείτε. Επικυρώστε την επιλογή σας με το πλήκτρο  (αν δεν πατήσετε κανένα πλήκτρο, η επιλογή θα επικυρωθεί αυτόματα μετά από λίγα δευτερόλεπτα).

ΟΘΟΝΗ ΠΛΗΡΟΦΟΡΙΩΝ ΜΑΓΕΙΡΕΜΑΤΟΣ

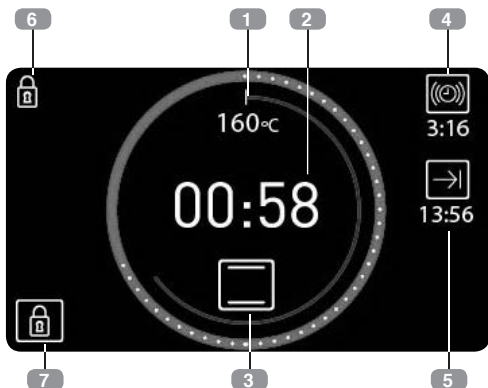

Κατά τη διάρκεια μαγειρέματος, οι πληροφορίες σχετικά με την κατάσταση του φούρνου θα εμφανίζονται κατανεμημένες γύρω από δύο κύκλους στο κέντρο:

Εσωτερικός κύκλος θερμοκρασίας: Με κόκκινο χρώμα. Εμφανίζει, σε κλίμακα, την επιλεγμένη θερμοκρασία.

Εξωτερικός κύκλος χρόνου:

- Ο κύκλος έχει κόκκινο χρώμα όταν εμφανίζεται ο χρόνος που ο φούρνος μαγειρεύει. Κάθε 2 λεπτά εμφανίζεται μία άσπρη κουκκίδα.
- Ο κύκλος έχει μπλε χρώμα όταν εμφανίζεται ο χρόνος που υπολείπεται για τη λήξη του μαγειρέματος (αντίστροφη μέτρηση). Κάθε 2 λεπτά εξαφανίζεται μία άσπρη κουκκίδα.

Στο κέντρο αυτών των κύκλων εμφανίζονται οι ακόλουθες πληροφορίες για το μαγείρεμα:

1. Επιλεγμένη θερμοκρασία. Το σύμβολο °C θα αναβοσβήνει ώσπου να επιτευχθεί η επιλεγμένη θερμοκρασία και όταν ο φούρνος μεταφέρει θερμότητα στα τρόφιμα.

2. Χρόνος Μαγειρέματος

- Αν δεν έχετε προγραμματίσει το ρολόι/timer, θα εμφανίζεται ο χρόνος που μαγειρεύει ο φούρνος. Η περιφέρεια του κύκλου που αντιστοιχεί στον χρόνο θα έχει κόκκινο χρώμα.
- Αν έχετε κάνει κάποιο προγραμματισμό στο ρολόι/timer, θα εμφανίζεται ο υπολείπόμενος χρόνος για τη λήξη του μαγειρέματος (αντίστροφη μέτρηση) και η περιφέρεια του κύκλου που αντιστοιχεί στον χρόνο θα έχει μπλε χρώμα.
- Αν ο φούρνος έχει προγραμματιστεί να ξεκινήσει τη λειτουργία του αργότερα και βρίσκεται σε κατάσταση αναμονής (δεν έχει ξεκινήσει το μαγείρεμα ακόμα) θα εμφανίζεται η συνολική προγραμματισμένη διάρκεια μαγειρέματος.

3. Επιλογή λειτουργίας μαγειρέματος ή αυτόματης συνταγής.

Εξωτερικά από τους κύκλους εμφανίζονται οι ακόλουθες πληροφορίες σχετικά με τις πρόσθετες λειτουργίες:

ΔΕΞΙΑ ΠΛΕΥΡΑ ΤΗΣ ΟΘΟΝΗΣ: Αν έχετε προγραμματίσει χρονικές λειτουργίες, οι πληροφορίες που αφορούν τις λειτουργίες αυτές εμφανίζονται στη δεξιά πλευρά της οθόνης.

4.  Βομβητής. Αντίστροφη μέτρηση με ηχητικό σήμα που προσδιορίζει την παρέλευση του χρόνου.

5.  Ώρα λήξης.

ΑΡΙΣΤΕΡΗ ΠΛΕΥΡΑ ΤΗΣ ΟΘΟΝΗΣ: Πληροφορίες σχετικά με τις ενεργοποιημένες λειτουργίες ασφαλείας.

6.  Κλείδωμα ηλεκτρολογίου. Θα ανάψει όταν είναι ενεργοποιημένο το κλείδωμα ασφαλείας για παιδιά.

7.  Κλείδωμα πόρτας. ΜΟΝΟ ΓΙΑ ΜΟΝΤΕΛΑ ΜΕ ΣΥΣΤΗΜΑ ΠΥΡΟΛΥΣΗΣ. Θα ανάψει όταν ενεργοποιηθεί το χειροκίνητο κλείδωμα πόρτας.

Μαγείρεμα με παραδοσιακές λειτουργίες φούρνου

ΛΕΙΤΟΥΡΓΙΕΣ ΤΟΥ ΦΟΥΡΝΟΥ



ΠΛΗΡΟΦΟΡΙΕΣ

Για την περιγραφή της χρήσης κάθε λειτουργίας, συμβουλευτείτε τον οδηγό μαγειρέματος που συνοδεύει τον φούρνο σας.

- | | | | |
|---|---|---|--------------------------------------|
|  | ΠΛΗΚΤΡΟ ΕΝΕΡΓΟΠΟΙΗΣΗΣ/
ΑΠΕΝΕΡΓΟΠΟΙΗΣΗΣ ΦΟΥΡΝΟΥ |  | ΓΚΡΙΑ |
|  | ΣΥΜΒΑΤΙΚΗ ⏶ |  | ΚΑΤΩ ΑΝΤΙΣΤΑΣΗ ⏶ |
|  | ΣΥΜΒΑΤΙΚΗ ΜΕ ΑΕΡΑ ⏶ |  | ΠΙΤΣΑ ⏶ |
|  | ΓΚΡΙΑ ΚΑΙ ΚΑΤΩ ΑΝΤΙΣΤΑΣΗ ⏶ |  | ΘΕΡΜΟΣ ΑΕΡΑΣ ⏶ |
|  | ΜΑΞΙ ΓΚΡΙΑ |  | ECO |
| | |  | ΑΡΓΟ ΜΑΓΕΙΡΕΜΑ |
| | |  | ΦΟΥΣΚΩΜΑ ΖΥΜΗΣ |
| | |  | ΑΠΟΨΥΞΗ |
| | |  | HYDROCLEAN |
| | |  | ΠΥΡΟΛΥΣΗ (ανάλογα το μοντέλο) |

⏶ Λειτουργίες με γρήγορη προθέρμανση

ΜΑΓΕΙΡΕΜΑ ΜΕ ΤΙΣ ΠΑΡΑΔΟΣΙΑΚΕΣ ΛΕΙΤΟΥΡΓΙΕΣ



Επιλογή λειτουργίας

Ενεργοποιήστε τον φούρνο πατώντας το πλήκτρο **1**.

Στρέψτε τον αριστερό διακόπτη στη λειτουργία που επιθυμείτε.

Στη συνέχεια, θα εμφανιστεί στη δεξιά πλευρά η συνιστώμενη θερμοκρασία για την επιλεγμένη λειτουργία.

Αν θέλετε, μπορείτε να τροποποιήσετε τη θερμοκρασία στρέφοντας τον δεξιά διακόπτη.

Επικυρώστε την επιλογή σας με το πλήκτρο **OK**.

Ο φούρνος θα ξεκινήσει το μαγείρεμα.

Οποιαδήποτε στιγμή κατά τη διάρκεια του μαγειρέματος μπορείτε:

- **Να αλλάξετε λειτουργία μαγειρέματος**, στρέφοντας τον αριστερό διακόπτη.

- **Να τροποποιήσετε τη θερμοκρασία μαγειρέματος** στρέφοντας τον δεξιά διακόπτη.
- **Να προγραμματίσετε μία ειδοποίηση ή διάρκεια/ώρα λήξης μαγειρέματος**. Πατήστε το πλήκτρο **⌚**.
- **Να τροποποιήσετε προγραμματισμένες ειδοποιήσεις ή προγραμματισμένη διάρκεια/ώρα λήξης**. Πατήστε το πλήκτρο **⌚**.



ΠΛΗΡΟΦΟΡΙΕΣ

Για να ρυθμίσετε ή να τροποποιήσετε μία ήδη προγραμματισμένη λειτουργία, συμβουλευτείτε την ενότητα «Ρύθμιση ρολογιού/timer φούρνου» που περιέχεται στη συνέχεια αυτού του οδηγού χρήσης.

ΑΥΤΟΜΑΤΗ ΓΡΗΓΟΡΗ ΠΡΟΘΕΡΜΑΝΣΗ

































Οι επισημασμένες λειτουργίες περιλαμβάνουν αυτόματη γρήγορη προθέρμανση.

Κατά τη διάρκεια της γρήγορης προθέρμανσης, ανάβει το σύμβολο **⏩**.

Συνιστάται να μην εισάγετε τα τρόφιμα στον φούρνο προτού σβήσει το σύμβολο αυτό.

Μαγείρεμα με τις προγραμματισμένες συνταγές (Personal Cooking Assistant)

ΑΥΤΟΜΑΤΕΣ ΣΥΝΤΑΓΕΣ ΤΟΥ ΦΟΥΡΝΟΥ

ΠΟΥΛΕΡΙΚΑ		 ΚΟΤΟΠΟΥΛΟ	
		 ΠΑΠΙΑ	
		 ΧΗΝΑ	
		 ΓΑΛΟΠΟΥΛΑ	
		 ΜΠΟΥΤΙΑ	
ΚΡΕΑΤΙΚΑ		 ΓΟΥΡΟΥΝΟΠΟΥΛΟ	 
		 ΒΟΔΙΝΟ	
		 ΑΡΝΙ	
		 ΜΠΡΙΖΟΛΕΣ	
ΨΑΡΙΑ		 ΜΠΑΚΑΛΙΑΡΟΣ	
		 ΣΟΛΟΜΟΣ	
ΨΩΜΙ		 ΛΕΥΚΟ ΨΩΜΙ	 
		 ΜΑΥΡΟ ΨΩΜΙ	
		 ΨΩΜΙ ΟΛΙΚΗΣ ΑΛΕΞΕΩΣ	
ΠΙΤΣΑ		 ΠΙΤΣΑ ΜΕ ΑΦΡΑΤΗ ΒΑΣΗ	 
		 ΠΙΤΣΑ ΜΕ ΛΕΠΤΗ ΒΑΣΗ	
ΓΛΥΚΑ		 ΓΛΥΚΟ ΣΕ ΦΟΡΜΑ	
		 ΓΛΥΚΟ ΜΕ ΦΡΟΥΤΑ ΜΕΓΑΛΟ	
		 ΓΛΥΚΟ ΜΕ ΦΡΟΥΤΑ ΜΙΚΡΟ	
		 ΓΛΥΚΟ ΣΕ ΤΑΨΙ	

 Συνταγές που απαιτούν προθέρμανση πριν την τοποθέτηση του φαγητού στον φούρνο.

 Συνταγές που απαιτούν γύρισμα του φαγητού.

ΓΙΑ ΝΑ ΜΑΓΕΙΡΕΨΤΕ ΜΕ ΤΙΣ ΠΡΟΓΡΑΜΜΑΤΙΣΜΕΝΕΣ ΣΥΝΤΑΓΕΣ (PCA)

Ενεργοποιήστε τον φούρνο πατώντας το πλήκτρο ①.

Πατήστε το πλήκτρο .



Επιλογή συνταγής

Στρέψτε τον αριστερό διακόπτη ώσου να εμφανιστεί το είδος τροφίμου που επιθυμείτε να μαγειρέψετε.

Στη συνέχεια θα εμφανιστούν στο αριστερό τμήμα της οθόνης οι διαθέσιμες συνταγές για το επιλεγμένο είδος τροφίμου. Επιλέξτε με τον δεξί διακόπτη τη συνταγή που επιθυμείτε και επικυρώστε την επιλογή σας με το πλήκτρο .

Στη συνέχεια θα εμφανιστούν στο δεξί τμήμα της οθόνης οι πληροφορίες που χρειάζεται ο φούρνος για να προγραμματίσει το μαγείρεμα.

Ανάλογα με τη συνταγή που θα επιλέξετε, ο φούρνος θα σας ζητήσει να εισάγετε:

ΒΑΡΟΣ ΤΡΟΦΙΜΟΥ: Επιλέξτε με τον δεξί διακόπτη και επικυρώστε με το πλήκτρο .

ΘΕΡΜΟΚΡΑΣΙΑ: Επικυρώστε τη θερμοκρασία που προτείνει η συνταγή ή επιλέξτε άλλη με τον δεξί διακόπτη και επικυρώστε με το πλήκτρο .

ΒΑΘΜΟΣ ΨΗΣΙΜΑΤΟΣ: Σε ορισμένες συνταγές μπορείτε να επιλέξετε τον βαθμό ψησίματος:

- **HIGH:** Καλοψημένο
- **MEDIUM:** Μέτρια ψημένο
- **LOW:** Ελάχιστα ψημένο

Αφού επιλέξετε όλες τις παραμέτρους, επικυρώστε με το πλήκτρο .

Ο φούρνος θα ξεκινήσει να μαγειρεύει και η οθόνη επιλογής θα μετατραπεί σε οθόνη μαγειρέματος όπου θα εμφανίζονται οι ακόλουθες πληροφορίες:

- Επιλεγμένη θερμοκρασία μαγειρέματος
- Υπολειπόμενος χρόνος μαγειρέματος
- Επιλεγμένη συνταγή

Μόλις λήξει το μαγείρεμα, θα εκπεμφθεί ηχητικό προειδοποιητικό σήμα διάρκειας 90 περίπου δευτερολέπτων και το σύμβολο μαγειρέματος θα αναβοσβήνει στην οθόνη. Πατήστε οποιοδήποτε πλήκτρο για να διακόψετε το ηχητικό σήμα.

Ο φούρνος θα σβήσει αυτόματα.



ΠΛΗΡΟΦΟΡΙΕΣ



Κατά τα πρώτα 10 λεπτά μαγειρέματος μπορείτε να τροποποιήσετε το βάρος και τον βαθμό ψησίματος ή να προγραμματίσετε ώρα λήξης του μαγειρέματος.

Μετά από αυτό το χρονικό διάστημα, οι τιμές αυτές παραμένουν σταθερές και δεν μπορούν να τροποποιηθούν.

Για να αλλάξετε αυτές τις τιμές μαγειρέματος, πατήστε το πλήκτρο  και ο φούρνος θα επιστρέψει στην οθόνη επιλογής.

Ακολουθήστε τα προαναφερόμενα βήματα.

Οποιαδήποτε στιγμή κατά τη διάρκεια του μαγειρέματος μπορείτε:

Να τροποποιήσετε τη θερμοκρασία μαγειρέματος, πατώντας το πλήκτρο . Επικυρώστε με το πλήκτρο .

Να ρυθμίσετε το ρολόι/timer, πατώντας το πλήκτρο .

Να τροποποιήσετε τον προγραμματισμό του ρολογιού/timer, πατώντας το πλήκτρο .

Για να προγραμματίσετε ή για να τροποποιήσετε μία ήδη προγραμματισμένη λειτουργία, ακολουθήστε τις οδηγίες στην ενότητα «Ρύθμιση ρολογιού/timer φούρνου» που περιέχεται στη συνέχεια αυτού του οδηγού χρήσης.

ΠΡΟΘΕΡΜΑΝΣΗ ΑΔΕΙΟΥ ΦΟΥΡΝΟΥ

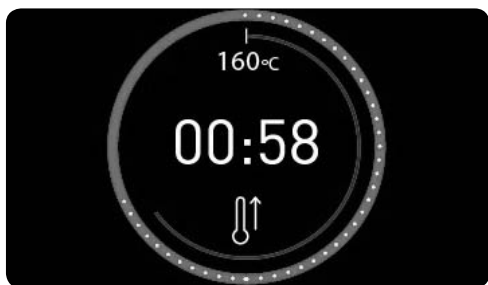

Οι συνταγές στον πίνακα που διαθέτουν σύμβολο , απαιτούν την προθέρμανση του φούρνου πριν τοποθετηθεί μέσα το τρόφιμο.

Όταν επιλέγετε μία από αυτές τις συνταγές, στην έναρξη του μαγειρέματος εμφανίζεται στην οθόνη το σύμβολο . Όταν φτάσει ο φούρνος στη θερμοκρασία μαγειρέματος, το σύμβολο θα αρχίσει να αναβοσβήνει και θα ηχήσει προειδοποιητικό σήμα, ένδειξη ότι πλέον μπορείτε να εισάγετε τα τρόφιμα.

Το προειδοποιητικό σήμα σταματά αυτόματα με το άνοιγμα της πόρτας του φούρνου για την εισαγωγή των τροφίμων, ενώ στην οθόνη θα εμφανιστεί ο υπολειπόμενος χρόνος.

Ρύθμιση Ρολογιού/Timer Φούρνου

ΕΠΙΛΟΓΕΣ ΡΥΘΜΙΣΗΣ ΡΟΛΟΓΙΟΥ/TIMER

Διαθέτετε τις ακόλουθες επιλογές για τον προγραμματισμό μαγειρέματος:

 **Βομβητής:** Παράγει ένα ηχητικό σήμα που εκπέμπεται με τη λήξη του προγραμματισμένου χρονικού διαστήματος. Το μαγείρεμα ΔΕΝ θα σταματήσει όταν παρέλθει το χρονικό διάστημα. Ο βομβητής μπορεί να προγραμματιστεί ακόμα και όταν ο φούρνος δεν μαγειρεύει.





ΠΛΗΡΟΦΟΡΙΕΣ

Μπορείτε να προγραμματίσετε τον βομβητή οποιαδήποτε στιγμή, ανεξάρτητα αν ο φούρνος σας μαγειρεύει ή όχι.

Οι υπόλοιπες επιλογές ρύθμισης χρόνου είναι διαθέσιμες μόνο όταν ο φούρνος μαγειρεύει.

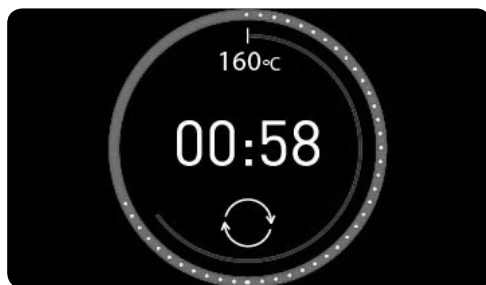
ΓΥΡΙΣΜΑ ΤΡΟΦΙΜΩΝ



Οι συνταγές στον πίνακα που διαθέτουν σύμβολο , απαιτούν να γυριστούν τα τρόφιμα κατά τη διάρκεια του μαγειρέματος.

Ο φούρνος θα σας ειδοποιήσει με προειδοποιητικό ηχητικό σήμα όταν πρέπει να γίνει αυτό και στην οθόνη μαγειρέματος θα εμφανιστεί το σύμβολο .

Το προειδοποιητικό ηχητικό σήμα σταματά αυτόματα μόλις ανοίξετε την πόρτα του φούρνου για να γυρίσετε τα τρόφιμα.

 **Διάρκεια μαγειρέματος:** Επιτρέπει την επιλογή του χρονικού διαστήματος που θα λειτουργήσει ο φούρνος.

Με τη λήξη του προγραμματισμένου χρονικού διαστήματος, θα ηχήσει προειδοποιητικό σήμα, το σύμβολο  θα αναβοσβήνει και ο φούρνος θα σταματήσει αυτόματα να θερμαίνεται.

Πατήστε οποιοδήποτε πλήκτρο για να παύσει το ηχητικό σήμα και να σβήσει ο φούρνος.

 **Ώρα λήξης μαγειρέματος:** Επιτρέπει την ρύθμιση της ώρας που θα σταματήσει ο φούρνος να λειτουργεί.

Με την έλευση της προγραμματισμένης ώρας, θα ηχήσει προειδοποιητικό σήμα, το σύμβολο  θα αναβοσβήνει και ο φούρνος θα σταματήσει αυτόματα να θερμαίνεται.

Πατήστε οποιοδήποτε πλήκτρο για να παύσει το ηχητικό σήμα και να σβήσει ο φούρνος.

Έναρξη μαγειρέματος με καθυστέρηση (|→) διάρκεια + (→) ώρα λήξης μαγειρέματος): Επιτρέπει τον προγραμματισμό του φούρνου ώστε να ξεκινήσει αυτόματα το μαγείρεμα και να σβήσει επίσης αυτόματα με την παρέλευση του προγραμματισμένου χρόνου μαγειρέματος.



ΠΛΗΡΟΦΟΡΙΕΣ

Για να προγραμματιστεί η επιλογή αυτή, θα πρέπει να προγραμματίσετε τη διάρκεια και την ώρα λήξης μαγειρέματος διαδοχικά.

Θα έχετε πρόσβαση στις επιλογές προγραμματισμού οποιαδήποτε στιγμή κατά τη διάρκεια μαγειρέματος.

Κατά τον ίδιο τρόπο, μπορείτε επίσης να τροποποιήσετε έναν ήδη υπάρχοντα προγραμματισμό.



ΠΛΗΡΟΦΟΡΙΕΣ

Αν έχετε επιλέξει μία αυτόματη συνταγή, ο φούρνος θα ορίσει αυτόματα τη διάρκεια μαγειρέματος και, κατά συνέπεια, η επιλογή αυτή δεν θα είναι διαθέσιμη.

Παρόλα αυτά, μπορείτε:

Να προγραμματίσετε την ώρα λήξης κατά τη διάρκεια των πρώτων δέκα λεπτών μαγειρέματος.

Να προγραμματίσετε τον βομβητή οποιαδήποτε στιγμή.

ΓΙΑ ΝΑ ΠΡΟΓΡΑΜΜΑΤΙΣΕΤΕ ΤΙΣ ΕΠΙΛΟΓΕΣ ΤΟΥ ΡΟΛΟΓΙΟΥ/TIMER

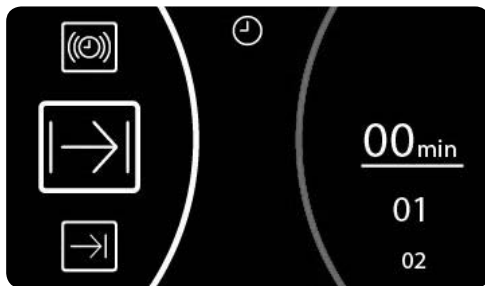

Προγραμματισμός κατά τη διάρκεια μαγειρέματος

1. Πατήστε το πλήκτρο για να εμφανιστεί το μενού επιλογών του ρολογιού/timer.
2. Στρέψτε τον αριστερό διακόπτη για να επιλέξετε τον επιθυμητό προγραμματισμό.
3. Στρέψτε τον δεξί διακόπτη για να επιλέξετε τη διάρκεια ή την ώρα λήξης, ανάλογα με την επιλογή προγραμματισμού που έχετε κάνει.



ΠΛΗΡΟΦΟΡΙΕΣ

Ο φούρνος δεν επιτρέπει την επιλογή λήξης προγενέστερης ώρας από την τρέχουσα ώρα.

Όταν προγραμματίσετε μία ώρα λήξης, θα εμφανιστεί στο κέντρο της οθόνης η τρέχουσα ώρα για να διευκολυνθείτε στην επιλογή σας.

4. Επικυρώστε την επιλογή σας με το πλήκτρο .
5. Στη συνέχεια, θα εμφανιστεί πάλι η οθόνη μαγειρέματος. Οι προγραμματισμένες ρυθμίσεις του ρολογιού/timer εμφανίζονται στα δεξιά του κεντρικού κύκλου.



Λειτουργίες ασφαλείας



ΚΛΕΙΔΩΜΑ ΑΣΦΑΛΕΙΑΣ ΓΙΑ ΠΑΙΔΙΑ (ΚΛΕΙΔΩΜΑ ΤΟΥ ΠΙΝΑΚΑ ΧΕΙΡΙΣΜΟΥ)

Η λειτουργία αυτή μπορεί να ενεργοποιηθεί οποιαδήποτε στιγμή:

- **Με τον φούρνο απενεργοποιημένο.** Με την ενεργοποίηση του κλειδώματος για παιδιά ο φούρνος δεν θα μπορεί να ενεργοποιηθεί όταν πιεστεί το πλήκτρο .

- **Κατά τη διάρκεια χρήσης του φούρνου.** Αν η λειτουργία ενεργοποιηθεί όσο ο φούρνος μαγειρεύει ή βρίσκεται σε αναμονή για να μαγειρέψει, το πληκτρολόγιο και ο διακόπτες θα κλειδώσουν και δεν θα ανταποκρίνονται, ενώ παράλληλα δεν θα μπορεί να τροποποιηθεί καμία τιμή.

Για να ενεργοποιηθεί η λειτουργία αυτή, πατήστε το πλήκτρο  για παρατεταμένο χρονικό διάστημα ώσπου να ακουστεί 1 χαρακτηριστικός ήχος και να εμφανιστεί στην οθόνη το σύμβολο . Ο πίνακας χειρισμού έχει τώρα κλειδώσει.

Για να απενεργοποιηθεί η λειτουργία αυτή, πατήστε πάλι το πλήκτρο  για παρατεταμένο χρονικό διάστημα ώσπου να ακουστεί 1 χαρακτηριστικός ήχος και να εξαφανιστεί από την οθόνη το σύμβολο .

ΧΕΙΡΟΚΙΝΗΤΟ ΚΛΕΙΔΩΜΑ ΠΟΡΤΑΣ

Διαθέσιμο μόνο σε μοντέλα με σύστημα πυρόλυσης.

Στα μοντέλα με σύστημα πυρόλυσης, το κλείδωμα ασφαλείας για παιδιά περιλαμβάνει και κλείδωμα της πόρτας καθιστώντας αδύνατο να την ανοίξει κάποιος.

Λειτουργία Teka Hydroclean®

Η λειτουργία αυτή διευκολύνει τον καθαρισμό λιπαρών και λοιπών υπολειμμάτων τροφών που έχουν προσκολληθεί στα τοιχώματα του φούρνου.

Για ευκολία στον καθαρισμό, αποφεύγετε τη συσσώρευση ρύπων. Καθαρίζετε τακτικά τον φούρνο.

ΠΡΟΓΡΑΜΜΑΤΙΣΜΟΣ ΛΕΙΤΟΥΡΓΙΑΣ TEKA HYDROCLEAN®



ΠΡΟΣΟΧΗ

Μη ρίχνετε νερό στο εσωτερικό του φούρνου όταν είναι ζεστός γιατί μπορεί να υποστεί φθορά το εμαγιέ.

Ο κύκλος καθαρισμού πρέπει να πραγματοποιείται πάντα με τον φούρνο κρύο. Εάν ο φούρνος είναι πολύ ζεστός, ενδέχεται να μην έχετε τα ίδια αποτελέσματα και να υποστεί φθορά το εμαγιέ.

Για να ανοίξετε την πόρτα θα πρέπει να απενεργοποιήσετε το κλείδωμα ασφαλείας για παιδιά ακολουθώντας τις παραπάνω οδηγίες.



ΠΡΟΣΟΧΗ

Προτού ενεργοποιήσετε το κλείδωμα, βεβαιωθείτε ότι η πόρτα του φούρνου είναι κλεισμένη σωστά. Αν η πόρτα δεν έχει κλείσει καλά, δεν θα κλειδώσει. Θα ηχήσει ένα προειδοποιητικό σήμα και στην οθόνη θα αναβοσβήνει το σύμβολο .

Αν συμβεί αυτό, κλείστε καλά την πόρτα για να εξαφανιστεί η προειδοποίηση και να ενεργοποιηθεί το κλείδωμα.

Αν δεν θέλετε να κλειδώσετε την πόρτα, απενεργοποιήστε την ασφάλεια για παιδιά.

Αφαιρέστε πρώτα τα ταψιά και όλα τα εξαρτήματα από το εσωτερικό του φούρνου, καθώς και τα στηρίγματα για τα ταψιά ή τους τηλεσκοπικούς οδηγούς.

Για να το κάνετε, ακολουθήστε τις οδηγίες που περιέχονται στο εγχειρίδιο εγκατάστασης και συντήρησης που σας παραδίδεται μαζί με τον φούρνο σας.

1. Σε κρύο φούρνο, απλώστε ένα απορροφητικό πανί κουζίνας (σπογγοπετσέτα) στο κάτω μέρος του φούρνου.

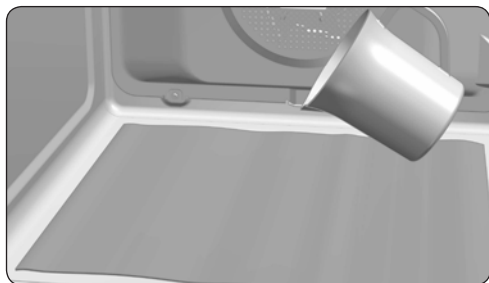



2. Ρίξτε αργά 200 ml νερό στο κάτω μέρος του θαλάμου του φούρνου.



ΠΛΗΡΟΦΟΡΙΕΣ

Για καλύτερα αποτελέσματα, προσθέστε ένα κουταλάκι ήπιο απορρυπαντικό για πιάτα στο νερό προτού το ρίξετε πάνω στο πανί κουζίνας.

3. Ενεργοποιήστε τον φούρνο, στρέψτε τον αριστερό διακόπτη για να επιλέξετε τη λειτουργία  και επικυρώστε με το πλήκτρο .

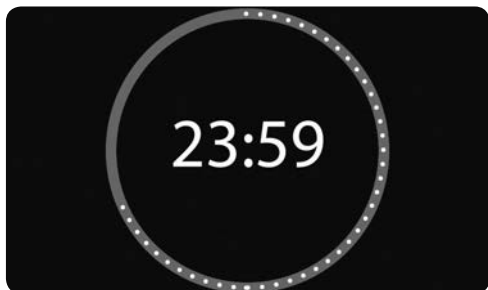

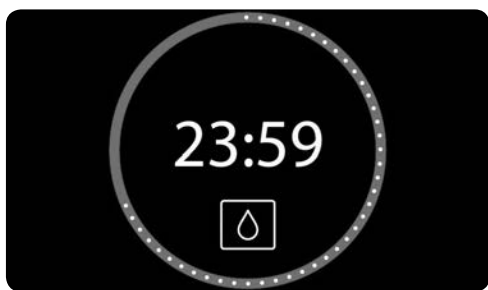

4. Στη συνέχεια, θα ακουστεί ηχητικό σήμα ως επιβεβαίωση ότι η λειτουργία Teka Hydroclean® έχει ξεκινήσει.

Στην οθόνη θα εμφανιστεί το σύμβολο  και ο χρόνος που υπολείπεται για τη λήξη της λειτουργίας.



ΣΗΜΑΝΤΙΚΟ

Η διάρκεια αυτής της λειτουργίας δεν μπορεί να τροποποιηθεί. Για να τη διακόψετε νωρίτερα, απενεργοποιήστε τον φούρνο με το πλήκτρο .

5. Όταν ολοκληρωθεί ο κύκλος καθαρισμού, ο φούρνος θα σβήσει, θα ακουστεί ένα ηχητικό σήμα και το σύμβολο  θα αναβοσβήνει γρήγορα.



ΣΗΜΑΝΤΙΚΟ

Μην ανοίγετε την πόρτα του φούρνου μέχρι να ολοκληρωθεί η λειτουργία Hydroclean®.

Η φάση ψύξης του φούρνου είναι απαραίτητη για τη σωστή λειτουργία της διαδικασίας καθαρισμού.

6. Αγγίξτε οποιοδήποτε πλήκτρο για να σταματήσει το ηχητικό σήμα και να σβήσει το σύμβολο .
7. Ο φούρνος θα απενεργοποιηθεί αυτόματα.
8. Τώρα μπορείτε με ένα υγρό πανί να απομακρύνετε όποια υπολείμματα ρύπων και το νερό που περισεύει.

Η λειτουργία Hydroclean® πραγματοποιείται σε χαμηλή θερμοκρασία. Το χρονικό διάστημα, ωστόσο, που απαιτείται για να κρυώσει ο φούρνος, μπορεί να διαφέρει ανάλογα με τη θερμοκρασία περιβάλλοντος.



ΠΡΟΣΟΧΗ

Πριν αγγίξετε απευθείας την εσωτερική επιφάνεια του φούρνου, βεβαιωθείτε ότι η θερμοκρασία είναι ανεκτή.

Αν, αφού πραγματοποιηθεί η λειτουργία Hydroclean® απαιτείται βαθύτερος καθαρισμός του φούρνου, χρησιμοποιήστε ουδέτερα απορρυπαντικά και σφουγγάρια που δεν προκαλούν διάβρωση.

Λειτουργία αυτοκαθαρισμού με σύστημα πυρόλυσης



ΠΡΟΣΟΧΗ

Προτού πραγματοποιήσετε έναν κύκλο καθαρισμού με πυρόλυση, διαβάστε προσεκτικά τις οδηγίες ασφαλείας που θα βρείτε στην αρχική ενότητα του οδηγού εγκατάστασης και συντήρησης.

Η λειτουργία αυτή σας δίνει τη δυνατότητα να πραγματοποιήσετε έναν κύκλο καθαρισμού με πυρόλυση κατά τη διάρκεια του οποίου, λόγω των υψηλών θερμοκρασιών που αναπτύσσονται στο εσωτερικό του φούρνου, πραγματοποιείται μια διαδικασία απανθράκωσης των συσσωρευμένων λιπών.

Κατά κανόνα, συνιστάται να πραγματοποιείται ένας κύκλος πυρόλυσης κάθε 4-5 χρήσεις του φούρνου και να επιλέξετε το καταλληλότερο πρόγραμμα ανάλογα με τη συσσώρευση βρωμιάς στον φούρνο σας. Όσο περισσότερη βρωμιά, τόσο μεγαλύτερης διάρκειας πρόγραμμα θα πρέπει να επιλέξετε.

Κατά τη διάρκεια εκτέλεσης της πυρόλυσης, ο εσωτερικός φωτισμός του φούρνου παραμένει σβησμένος.

ΠΡΟΓΡΑΜΜΑΤΙΣΜΟΣ ΤΗΣ ΛΕΙΤΟΥΡΓΙΑΣ ΠΥΡΟΛΥΣΗΣ



ΣΗΜΑΝΤΙΚΟ

Προτού πραγματοποιήσετε τον κύκλο καθαρισμού με πυρόλυση, αφαιρέστε πρώτα τα ταψιά και όλα τα εξαρτήματα από το εσωτερικό του φούρνου καθώς και τα στηρίγματα για τα ταψιά ή τους τηλεσκοπικούς οδηγούς. Για να το κάνετε, ακολουθήστε τις οδηγίες που περιέχονται στο εγχειρίδιο εγκατάστασης και συντήρησης που σας παραδίδεται μαζί με τον φούρνο σας.



ΠΡΟΣΟΧΗ

Αφαιρέστε από το εσωτερικό του φούρνου υπερβολικά υπολείμματα βρωμιάς, καθώς,

κατά τη διαδικασία της πυρόλυσης μπορεί να αναφλεγούν και να προκύψει κίνδυνος πυρκαγιάς.



ΠΡΟΣΟΧΗ

Προτού ενεργοποιήσετε τη διαδικασία πυρόλυσης, βεβαιωθείτε ότι η πόρτα του φούρνου έχει κλείσει σωστά.

1. Ενεργοποιήστε τον φούρνο και επιλέξτε τη λειτουργία πυρόλυσης  στρέφοντας τον αριστερό διακόπτη.

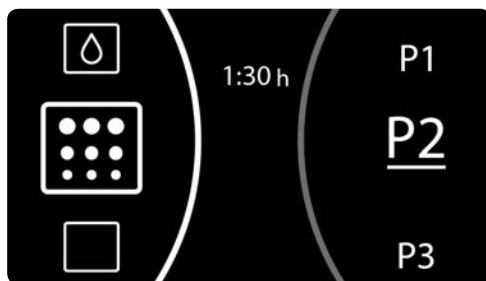

2. Με τον δεξιά διακόπτη επιλέξτε το καταλληλότερο πρόγραμμα πυρόλυσης ανάλογα με τα επίπεδα της βρωμιάς στον φούρνο σας:
 - P1:** Ήπια πυρόλυση. Διάρκεια: 1 ώρα.
 - P2:** Κανονική πυρόλυση. Διάρκεια: 1 ώρα και 30 λεπτά.
 - P3:** Εντατική πυρόλυση. Διάρκεια: 2 ώρες.
3. Επικυρώστε την επιλογή σας με το πλήκτρο . Αμέσως μετά, θα τεθεί σε λειτουργία το αυτόματο κλείδωμα της πόρτας.



ΠΡΟΣΟΧΗ

Αν η πόρτα δεν έχει κλείσει καλά, η πυρόλυση δεν θα τεθεί σε λειτουργία. Θα ηχήσει ένα προειδοποιητικό σήμα και το σύμβολο  θα αναβοσβήνει στην οθόνη.

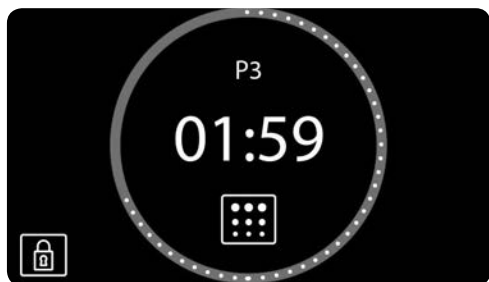

Αν συμβεί αυτό, κλείστε καλά την πόρτα για να ενεργοποιηθεί το κλείδωμα και να τεθεί σε λειτουργία η διαδικασία πυρόλυσης.

4. Όταν κλειδώσει η πόρτα, θα ανάψει στην οθόνη του ρολογιού το σύμβολο  και θα εμφανιστεί ο υπολειπόμενος χρόνος έως τη λήξη της διαδικασίας πυρόλυσης.



ΣΗΜΑΝΤΙΚΟ

Ο φούρνος έχει προγραμματιστεί και εκτελεί τον κύκλο καθαρισμού με πυρόλυση.

Κατά τη διάρκεια των πρώτων 10 λεπτών μπορείτε να επιλέξετε να καθυστερήσει η έναρξη της διαδικασίας πυρόλυσης προγραμματίζοντας την ώρα λήξης της. Για να το κάνετε, πατήστε το πλήκτρο  για να εμφανιστεί το μενού επιλογών ρολογιού/timer. Αφού επιλέξετε την ώρα λήξης, επικυρώστε με το πλήκτρο .

Κατά τη διάρκεια της διαδικασίας πυρόλυσης δεν μπορείτε να επιλέξετε καμία άλλη εκδοχή του ρολογιού/timer. Μπορείτε όμως να ενεργοποιήσετε το κλείδωμα ασφαλείας για παιδιά, αν το επιθυμείτε.

Μην επιχειρήσετε επίσης να ανοίξετε την πόρτα του φούρνου γιατί μπορεί να διακοπεί η διαδικασία καθαρισμού.

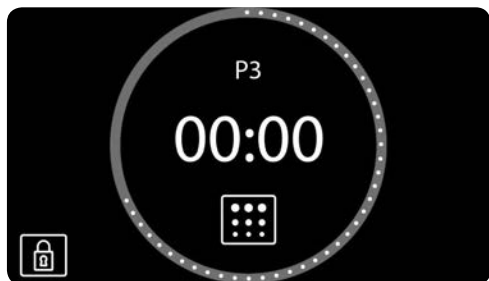

5. Όταν ολοκληρωθεί ο καθαρισμός με το σύστημα πυρόλυσης, θα ακουστεί ένα ηχητικό σήμα, το σύμβολο  θα αναβοσβήνει και στην οθόνη του ρολογιού θα εμφανίζεται 0:00.

6. Πατήστε οποιοδήποτε πλήκτρο του ρολογιού για να παύσει το ηχητικό σήμα

7. Ο φούρνος θα σβήσει αυτόματα.

8. Η διαδικασία θέρμανσης του φούρνου έχει ολοκληρωθεί, αλλά ο φούρνος είναι υπερβολικά ζεστός για να χρησιμοποιηθεί.

Η διαδικασία ψύξης θα συνεχίσει να λειτουργεί και το σύμβολο  θα παραμένει αναμμένο μέχρι να κρυώσει ο φούρνος.



ΣΗΜΑΝΤΙΚΟ

Λόγω των υψηλών θερμοκρασιών που αναπτύσσονται στο εσωτερικό του φούρνου, ο χρόνος ψύξης μπορεί να διαφέρει ανάλογα με τη θερμοκρασία περιβάλλοντος.

9. Μόλις κρυώσει ο φούρνος σας, το σύμβολο  θα σβήσει και η πόρτα θα ξεκλειδώσει.
10. Ανοίξτε την πόρτα του φούρνου και σκουπίστε με ένα βρεγμένο πανί κουζίνας το εσωτερικό του θαλάμου αφαιρώντας τη στάχτη που δημιουργήθηκε κατά τη διάρκεια του κύκλου καθαρισμού. Στα εσωτερικά σημεία του φούρνου με δύσκολη πρόσβαση, θα χρειαστεί να καθαρίσετε με σφουγγάρι από μη μεταλλικές ίνες.
11. Αφού ολοκληρωθεί ο καθαρισμός, μην ξεχάσετε να τοποθετήσετε ξανά στο εσωτερικό του φούρνου τα στηρίγματα και τα εξαρτήματα του.
12. Ο φούρνος είναι πάλι έτοιμος για χρήση.



ΣΗΜΑΝΤΙΚΟ

Αν παρατηρήσετε κάποια ανωμαλία στον προγραμματισμό και τον χειρισμό της λειτουργίας αυτής, συμβουλευτείτε τον οδηγό εγκατάστασης και συντήρησης που συνοδεύει τον φούρνο σας.

ΑΚΥΡΩΣΗ ΤΗΣ ΔΙΑΔΙΚΑΣΙΑΣ ΠΥΡΟΛΥΣΗΣ

Η πυρόλυση είναι μια αυτόματη διαδικασία και, κατά συνέπεια, μπορεί μόνο να ενεργοποιηθεί με προγραμματισμό του ρολογιού. Για να ακυρώσετε έναν κύκλο πυρόλυσης που βρίσκεται σε εξέλιξη, θα πρέπει να ακυρώσετε τον προγραμματισμό του φούρνου ακολουθώντας τα παρακάτω βήματα:

1. Πατήστε το πλήκτρο ①.

Η διαδικασία πυρόλυσης θα διακοπεί.

2. Ανάλογα με τη θερμοκρασία στο εσωτερικό του φούρνου, μπορεί να προκύψουν οι ακόλουθες δύο περιπτώσεις:

α) Θερμοκρασία στο εσωτερικό σε επικίνδυνα επίπεδα: Στην περίπτωση αυτή, η πόρτα θα παραμείνει κλειδωμένη ώσπου η θερμοκρασία να φτάσει σε ασφαλή επίπεδα. Στην οθόνη θα εμφανιστεί το σύμβολο .

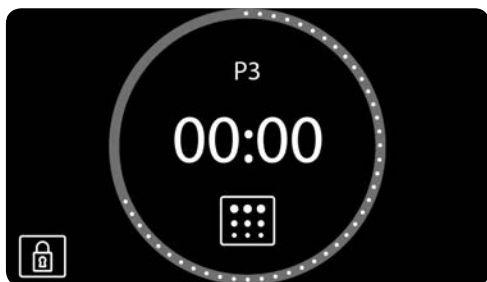

Μόλις η πόρτα ξεκλειδώσει και μπορεί να ανοιχθεί, το σύμβολο  θα εξαφανιστεί και θα εμφανιστεί πάλι στην οθόνη του ρολογιού η ώρα.

β) Θερμοκρασία στο εσωτερικό σε ασφαλή επίπεδα: Αν η θερμοκρασία στο εσωτερικό του φούρνου είναι ασφαλής, η πόρτα θα ξεκλειδώσει αυτόματα.

3. Θερμοκρασία στο εσωτερικό σε ασφαλή επίπεδα: Αν η θερμοκρασία στο εσωτερικό του φούρνου είναι ασφαλής, το ξεκλείδωμα θα ενεργοποιηθεί αμέσως και η οθόνη του φούρνου θα επανέλθει στην οθόνη αναμονής.

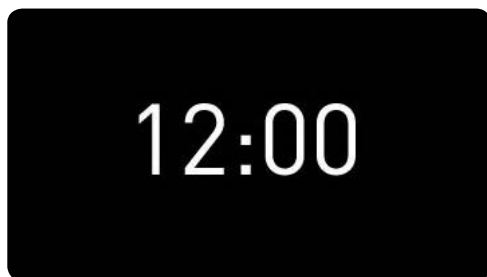

**ENERG**

енергия · ενεργεια

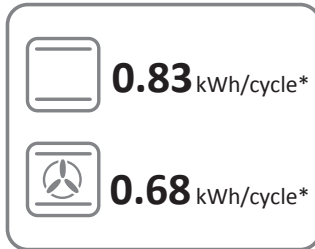
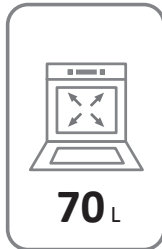
Y IJA
IE IA**HLB 860**

* цикл · cyclus · portion · zyklus · πρόγραμμα · ciclo · tsükkel · ohjelma · ciklus · ciklas · cikls · ciklu · cyclus · cykl · ciclu · program · cykel

65/2014

EEI _{cav} *	81
N ^o cav *	1
M	31 kg

* затв.отдел. · ovnrum · θαλάμου · prostor za pečenje · kavità · ovenruimte · incintă · prostor za peko · kavitet



ENERG Y IJA
 енергия · ενεργεια
 IE IA



HLB 860 P

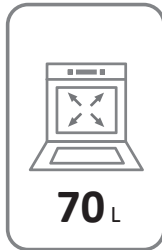

70 L

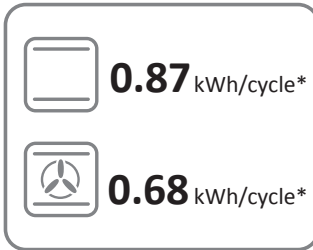

* цикъл · cyclus · portion · zyklus · πρόγραμμα · ciclo · tsükkel · ohjelma · ciklus · ciklas · cikls · ciklu · cyclus · cykl · ciclu · program · cykel

65/2014

EEI _{cav} *	81
N° cav *	1
M	36 kg

* затв.отдел. · onnrum · θαλάμιου · prostor za rešenje · kavità · ovenruimte · incintă · prostor za peko · kavitet

Nuestra aportación a la protección del medio ambiente: utilizamos papel reciclado.
 A nossa contribuição para a proteção do ambiente: utilizamos papel reciclado.
 Our contribution to environmental protection: we use recycled paper.
 Notre contribution à la protection de l'environnement : nous utilisons du papier recyclé.
 Unser Beitrag zum Umweltschutz: wir verwenden umweltfreundliches Papier.
 Onze bijdrage aan de bescherming van het milieu: wij gebruiken kringloppapier.
 Η συνεισφορά μας στην προστασία του περιβάλλοντος: χρησιμοποιούμε ανακυκλωμένο χαρτί.
 Cod: 83370605/5370605-02

